

# SLIDERS CATALOGUE

スライダーカタログ





# INDEX

YKK Original sliders for METAL ZIPPERS  
メタルファスナー用スライダー

## METAL ZIPPERS

3M	_____	01 - 04
3Y	_____	05 - 08
4M(Y)	_____	09 - 10
4Y	_____	11
5M(Y)	_____	12 - 16
7M	_____	17 - 18
8M(Y)	_____	19
10M	_____	20

## EXCELLA®

2SG	_____	21
3SG	_____	22
5SG	_____	23
8SG	_____	24

## L-TYPE ZIPPERS

2SL	_____	25
-----	-------	----

## COIL ZIPPERS

2C(CF)	_____	26
3C(CF)	_____	27 - 32
45C(CF)	_____	33 - 34
5CN(CI)	_____	35 - 41
8C(CF)	_____	42 - 43
10C(CF)	_____	44

## CONCEAL®

2CC(CH)	_____	45
3CC(CH)	_____	46
5CC(CH)	_____	47

## EFLON®

0EF	_____	48
4EF	_____	49
5EF	_____	50

## 靴専用織り込みファスナー

65EY	_____	51
------	-------	----

## FLATKNIT®

25FK	_____	52
------	-------	----

## VISLON®

3VS	_____	53 - 55
4VS	_____	56 - 57
5VS	_____	58 - 61
8VS	_____	62 - 63
10V(VF)	_____	64 - 65
15V	_____	66

## PROSEAL®

4TZN	_____	67
8TZN	_____	68

YKK Original sliders for COIL ZIPPERS  
コイルファスナー用スライダー

YKK Original sliders  
for VISLON®  
VISLON®ファスナー用スライダー

for METAL ZIPPERS

for COIL ZIPPERS

for VISLON®

for PROSEAL®

※【】= アイテムコード

# SLIDER (スライダー)とは

ファスナーを開閉するときに  
エレメントをかみあわせたり、  
離したりする役目をするものです。

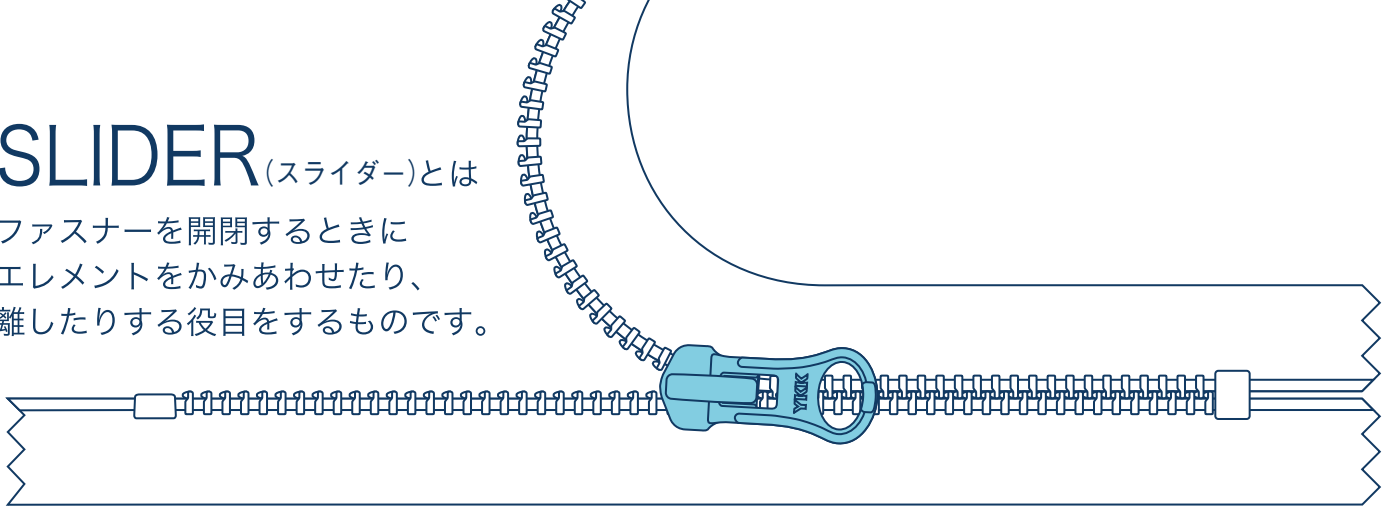

## スライダー各部の名称

### オートマチックロックスライダー

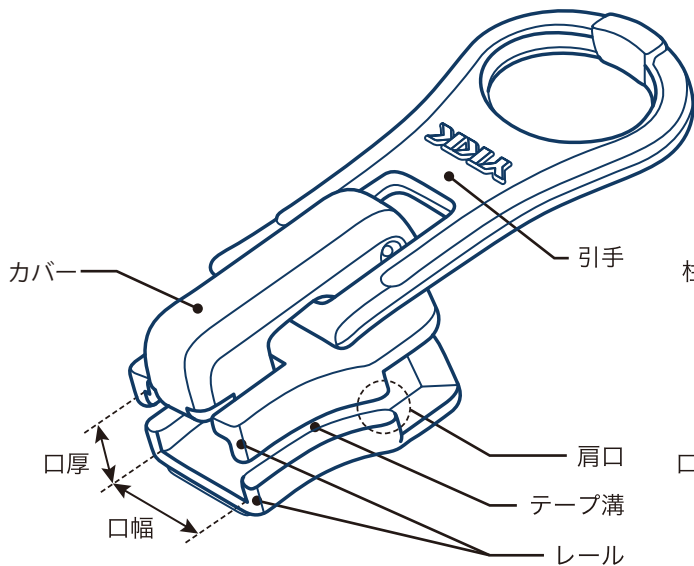

### 自由スライダー

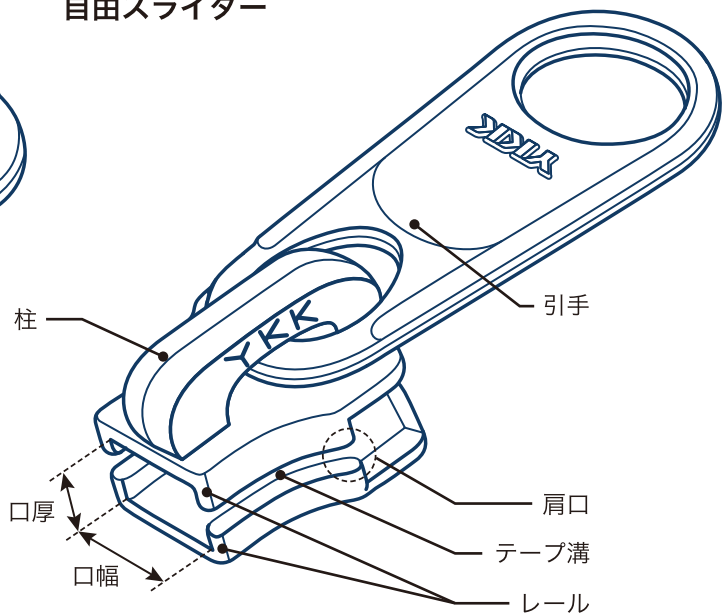

### 直付けタイプ

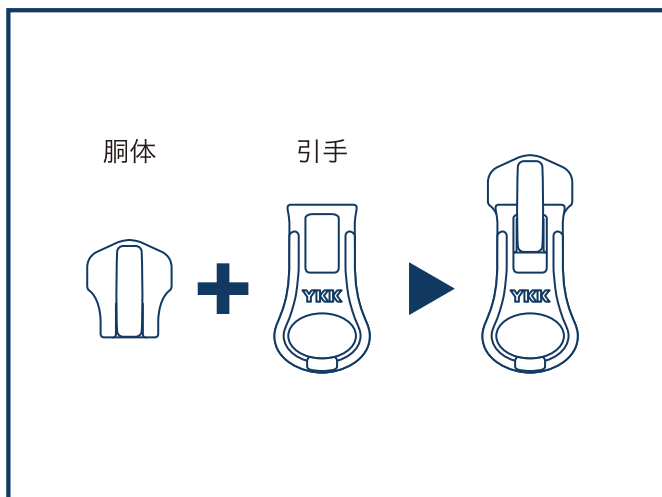

### クランパータイプ

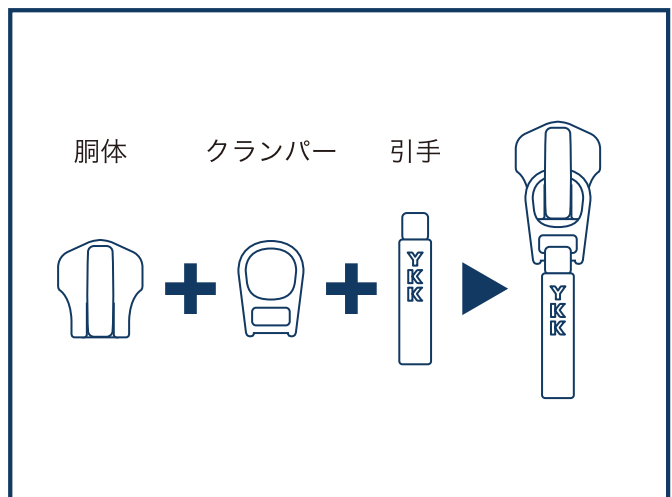

## アクセサリー 後付けスライダー

- ・取り付ける引手の大きさや重さ、取付部分の形状に注意が必要です。
- ・極端に大きな引手や、重い引手の取り付けはおやめください。重さにより、ファスナーが開いてくることがあります。
- ・また、引手の取付部分の寸法が適切であることをご確認下さい。

引手を後から取り付けることができるスライダーには、以下のような種類があります。

### ●【CA・CF】— スライダーに付いている小型のナスカンに引手を取り付けるタイプ —

引手は、【CA・CF】専用に設計された取り付け部形状のものをお選びください。  
規格外の引手を取り付けますと、ナスカン部分を破損するおそれがあります。

#### 【CA】 オートマチックロック機能付き

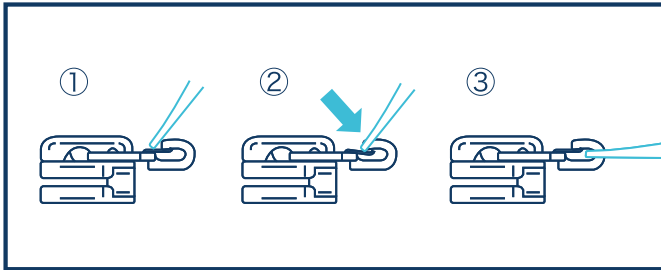

#### 【CF】 ノンロック(自由)

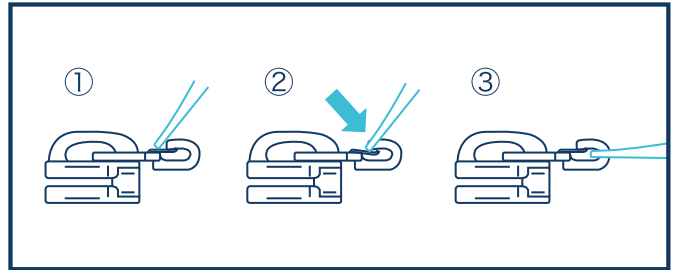

### ●【ZA・ZF】— スライダーの胴体に直接引手を取り付けるタイプ —

引手は、【ZA・ZF】対応のものをお選びください。  
規格外の引手を取り付けますと、スライダーを破損するおそれがあります。

#### 【ZA】 オートマチックロック機能付き

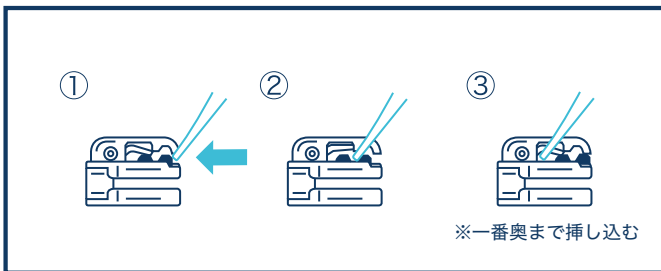

#### 【ZF】 ノンロック(自由)

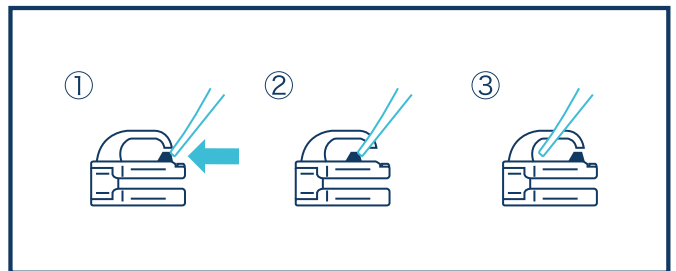

## 引手後付け用スライダー ご使用時の注意事項

引手後付け用スライダーには上記の他に、【DADC・DFDC・DFNT2】等、工具を使って取り付けるタイプもあります。

取り付ける引手寸法や取り付け方法により、製品機能や外観に影響を及ぼす可能性があります。

以下を十分ご理解のうえ、ご使用いただきますようお願いいたします。

- ・お客様で引手を作成される際には、取り付け部形状など弊社営業担当者までお問い合わせください。
- ・一度取り付けした引手を取り外す等の再加工はしないでください。
- ・加工時及び使用時に剥がれる可能性が高い塗装品(一部のめっき品)のご使用はお勧めいたしません。

YKKでは、当社以外の第三者が製造した部品または第三者が行った加工に起因する当社製品の品質・性能について、一切責任を負いかねますので何卒、ご理解いただきますようお願い申し上げます。

## 引手付スライダーの引手部分に紐やテープ・革などを取り付ける場合

極端に長いもの、大きなものを取り付けるのはおやめください。

長さ・大きさがあることで、スライダーから離れた部分を持つての操作となり、ファスナーに過度の負荷がかかります。

また、持ち手部分が大きくなることで、力を入れやすく無理な操作につながります。

いずれも破損の原因となりますので、ご注意ください。

さらに重さのあるものを取り付けますと、重さによりファスナーが開いてくることがあります。

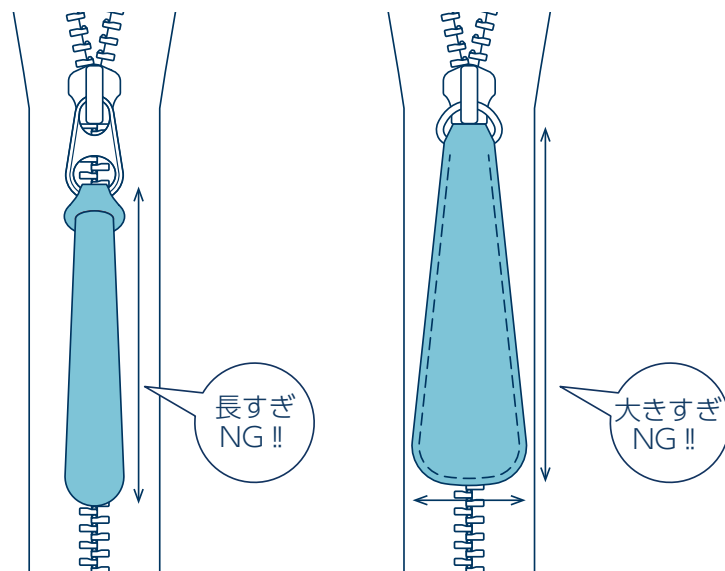

## 両面・回転スライダー使用上のご注意 ⚠

両面（または回転）オートマチックスライダーはその構造上、下図に示す矢印 ➡ の方向に力がかけると、ロックが解除されスライダーが下がる（ファスナーが開く）おそれがあります。

リバーシブルパンツや身体にフィットするようなウェアにご使用の場合は、事前の確認を行ってください。

### 両面オートマチックスライダー

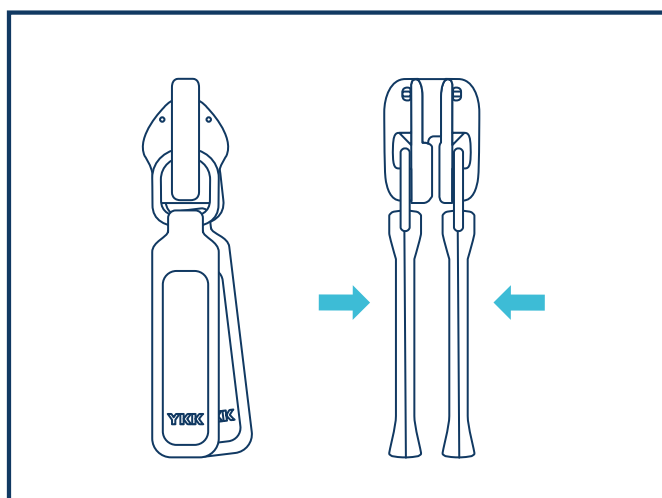

### 回転オートマチックスライダー

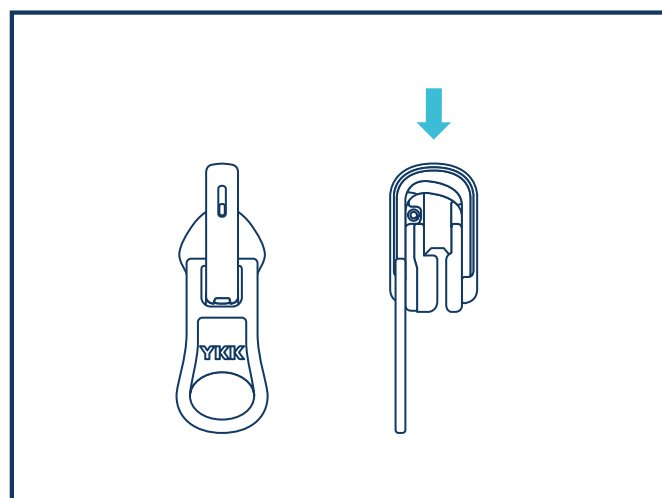

**3M** ファスナーアイテムコード 「ファスニング専科」をご覧ください

**D** 材質コード 次ページ一覧をご参照ください

**A** 機能コード 次ページ一覧をご参照ください

**LH5** 引手コード

**NC-F 08**

検針機対応 鋼球(鉄球)換算値	アクセサリ引手用 後付けスライダー	止製品 専用
NC-F 06    NC-F 07    NC-F 08		

**DALH5**  
AUTOMATIC LOCK

## 検針機対応の表記について

検針機は金属の中でも磁性金属(鉄など)に強く反応します。

また、残針の検査は検針機の原理上商品を動かして(移動させて)行うため、非磁性金属(銅・アルミ・真鍮など)でも渦電流が発生し微弱ながら反応することがあります。

お客様の検針検査基準に応じてファスナーが選択できるよう、質量、表面積、形状の違いによるファスナーの実測値を商品コード【NC-F06/07/08】に表記しています。

【NC-F06】	【NC-F07】	【NC-F08】
<b>NC-F 06</b>	<b>NC-F 07</b>	<b>NC-F 08</b>
Φ0.6 鋼球(鉄球)相当	Φ0.7 鋼球(鉄球)相当	Φ0.8 鋼球(鉄球)相当

- 【NC-F06/07/08】は、ファスナー単体の鋼球(鉄球)換算値をグループ分けした名称であり、検針検査基準や検針機の設定を示すものではありません。
- お客様の検針検査に適合することを保証するものではありません。  
お客様の検査基準/検針機に適合するか事前にご確認のうえ、ファスナーをお選びください。
- ニッケルめっき等、一部の表面処理は検針非対応です。
- スライダーの鋼球(鉄球)の換算値につきましては、スライダーカタログにてご確認いただけます。
- スライダーカタログに掲載のないものやご不明な点につきましては、弊社営業担当までお問い合わせください。

## 材質コード

コード	材質	コード	材質
D	亜鉛合金材	N	ポリアミド系樹脂
G	銅合金材	S	ステンレス
K	銅合金材強力タイプ	T	ポリエステル系樹脂

## 機能コード

コード	種類	特徴
A	オートマチック ロックスライダー	引手から手を離すと自動的にロック がかかり、引手を引っ張ること によってロックが外れる
C	カムロックスライダー (ロールストップ)	引手のカムがチェーンエレメントを 押さえ込み、それによってロックが 作用するスライダー
D	両面肩止スライダー	両面に引手があり表裏いずれからも 引手を持って開閉することができる
F	ノンロック (自由スライダー)	引手が胴体のどの位置にあっても ロック作用を持たないスライダー
K	キーロック付き スライダー	鍵でロックができる
L	鍵穴付き スライダー	鍵穴に南京錠等を通して、施錠する ことができる
N	ノッチロック (肩止)	胴体肩口にノッチが付いていて チェーンを肩口に当てるように開く とロックする
P	ピンロック (爪止)	引手についている爪がエレメントに 働き、ロックが作用するスライダー
R	回転 (自由・肩止) スライダー	一枚の引手が回転レールに沿って 移動できるもので表裏いずれからも 開閉できるリバーシブルタイプ
S	セミオートマチック ロックスライダー	スプリングにより引手の位置が固定 されるタイプで引手を下げた状態で ロックがかかり、引手を起こした状 態でロックが外れる
U	回転オートマチック スライダー	一枚の引手が回転レールに沿って 移動できるもので表裏いずれからも 開閉できるリバーシブルタイプ
W	両面自由スライダー	両面に引手があり表裏いずれからも 引手を持って開閉することができる
X	両面オートマチック スライダー	両面に引手があり表裏いずれからも 引手を持って開閉することができる
Z	簡易ロック スライダー	胴体についているレバーを倒せば ロックがかかり起こすとロックが 外れる

## 表面処理コード

コード	仕様	カラー
EJ	Enamel Painted 塗装	
P	Premium Nickel 高級ニッケルメッキ	
N	Nickel ニッケルメッキ	
C5	Silver シルバームッキ	
C6	Matte Silver マットシルバームッキ	
H3	Antique Silver アンティークシルバームッキ	
V3	Black Silver ブラックシルバームッキ	
X6J	Black Oxides マットブラック	
Q	Real Gold 本金メッキ	
OU	Premium Gold 高級ゴールドメッキ	
O	Gold ゴールドメッキ	
KQ	Rose Gold クリアゴールドメッキ	
I	Antique Brass アンティークゴールドメッキ	

- 写真は印刷物のため、実物とは多少異なることがあります
- 樹脂スライダーの場合、塗装はEW等のコードになります
- 印は検針対応可能な表面処理です



# 3M

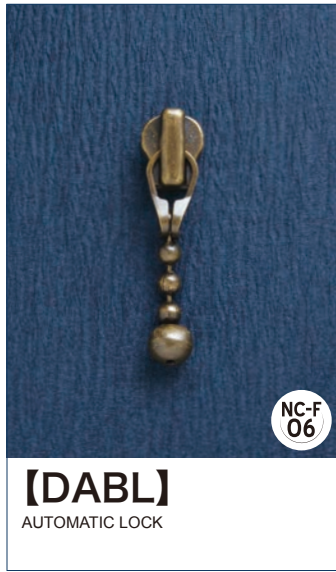

# YKK original sliders for METAL ZIPPERS

## 3M

for METAL ZIPPERS

3M

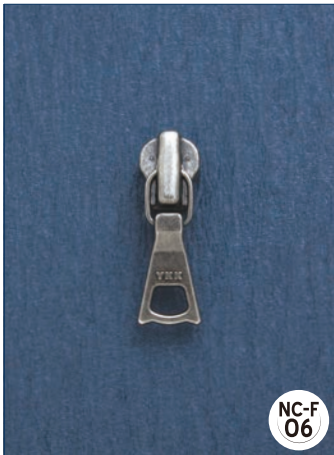

NC-F  
06

**【DATDR2】**  
AUTOMATIC LOCK

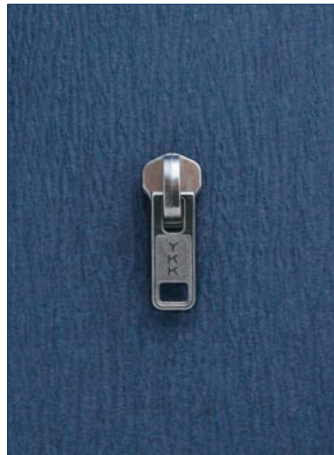

**【DF】**  
NON LOCK

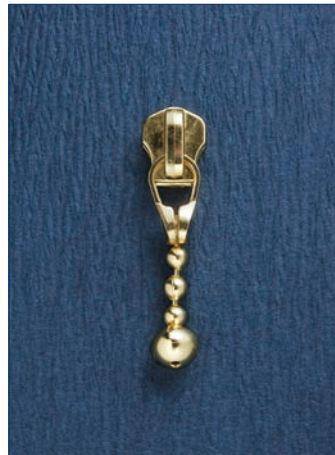

**【DFBL】**  
NON LOCK



**【DFCA】**  
NON LOCK

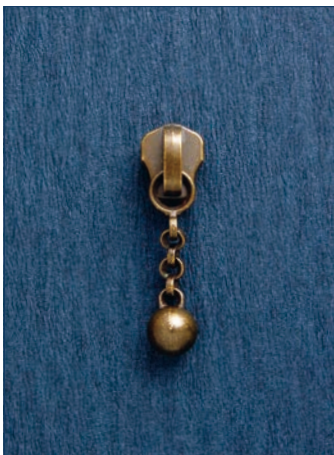

**【DF CAB】**  
NON LOCK

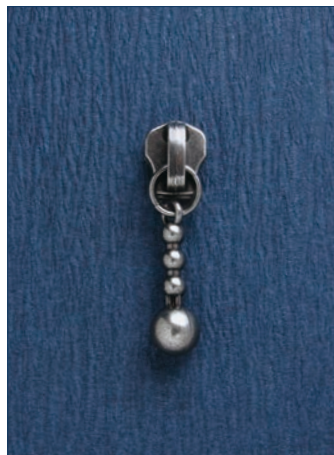

**【DFDBL】**  
NON LOCK



**【DFDC3】**  
NON LOCK  
HOOK-CRAMPER



**【DFDR3】**  
NON LOCK

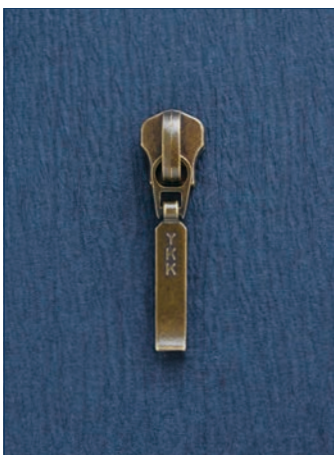

**【DFDR4】**  
NON LOCK



**【DFDRB】**  
NON LOCK



**【DFDR11】**  
NON LOCK



**【DFDR12】**  
NON LOCK

# 3M



**【DFDR13】**  
NON LOCK

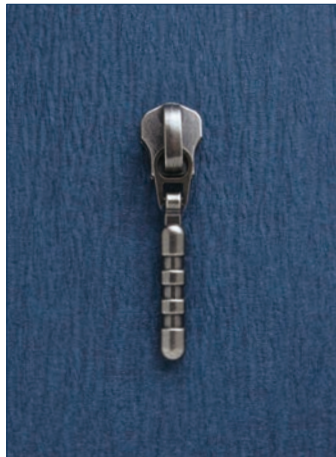

**【DFDR14】**  
NON LOCK



**【DFDR15】**  
NON LOCK

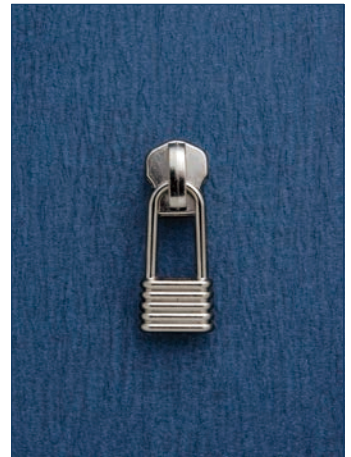

**【DFDHH1】**  
NON LOCK



**【DFL】**  
NON LOCK

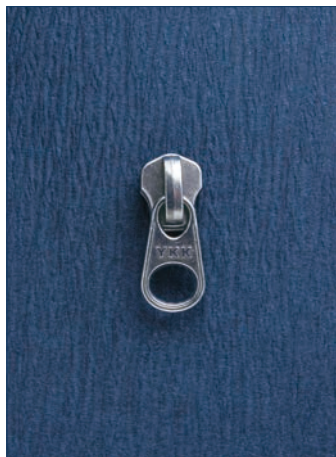

**【DFW】**  
NON LOCK



**【DFWF】**  
NON LOCK



**【DNCA】**  
NOTCH LOCK



**【DNCAB】**  
NOTCH LOCK

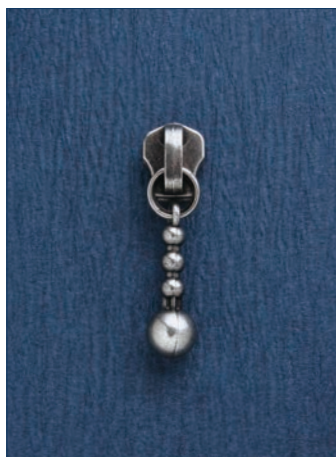

**【DNDBL】**  
NOTCH LOCK



**【DNDR3】**  
NOTCH LOCK



**【DNP1】**  
NOTCH LOCK

# YKK original sliders for METAL ZIPPERS

## 3M

for METAL ZIPPERS

3M



**[DNP2]**  
NOTCH LOCK



**[CA]**  
AUTOMATIC LOCK  
CLIP ON CRAMPER FOR ACCESSORY TAB

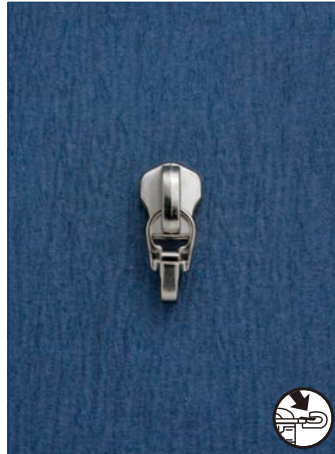

**[CF]**  
NON LOCK  
CLIP ON CRAMPER FOR ACCESSORY TAB

# 3Y



**NC-F 06**

**【DA】**  
AUTOMATIC LOCK



**NC-F 07**

**【DA11】**  
AUTOMATIC LOCK  
PRESS



**NC-F 06**

**【DABL】**  
AUTOMATIC LOCK



**NC-F 06**

**【DADHR5】**  
AUTOMATIC LOCK



**NC-F 07**

**【DADRB】**  
AUTOMATIC LOCK



**NC-F 06**

**【DADR3】**  
AUTOMATIC LOCK



**NC-F 06**

**【DADR4】**  
AUTOMATIC LOCK



**NC-F 06**

**【DADR11】**  
AUTOMATIC LOCK



**NC-F 06**

**【DADR12】**  
AUTOMATIC LOCK



**NC-F 06**

**【DADR13】**  
AUTOMATIC LOCK



**NC-F 06**

**【DADR14】**  
AUTOMATIC LOCK



**NC-F 06**

**【DADR15】**  
AUTOMATIC LOCK

# YKK original sliders for METAL ZIPPERS

## 3Y

for METAL ZIPPERS

3Y

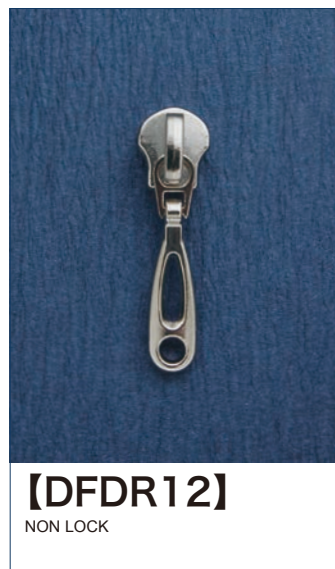
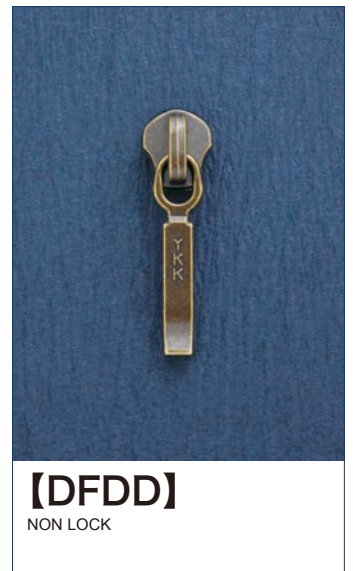
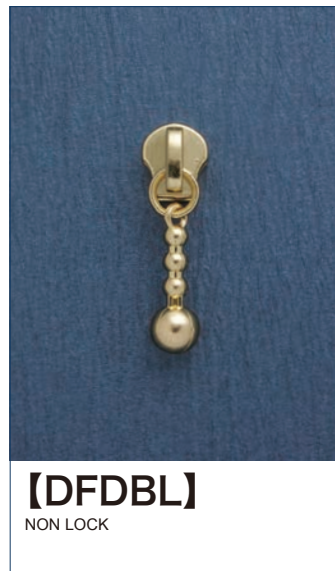
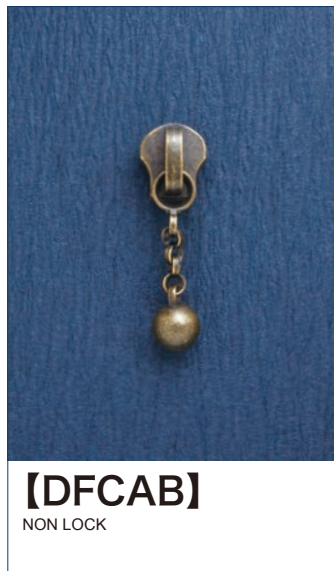
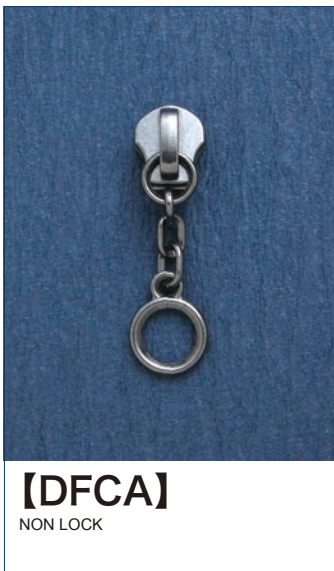
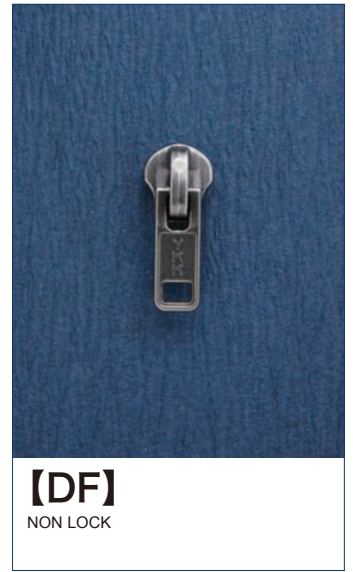

# 3Y

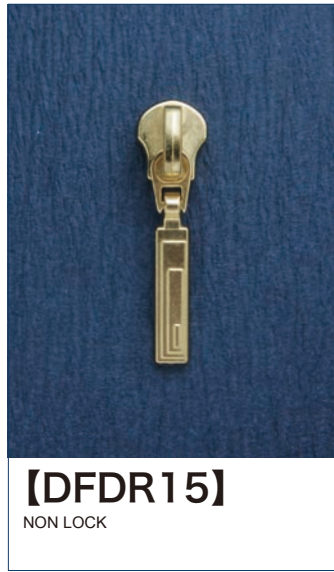

# YKK original sliders for METAL ZIPPERS

## 3Y

for METAL ZIPPERS

3Y

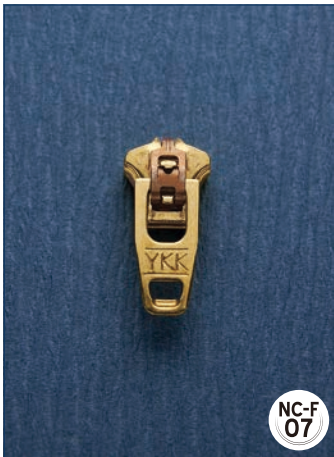

**[GSBN8]**

SEMI-AUTOMATIC LOCK / DUAL POSITION  
PRESS



**[GSBN8JNS]**

SEMI-AUTOMATIC LOCK / DUAL POSITION  
PRESS / JEANS MARK



**[CA]**

AUTOMATIC LOCK  
CLIP ON CRAMPER FOR ACCESSORY TAB



**[ZF]**

NON LOCK  
SNAP-ON TYPE



# 4M (Y)

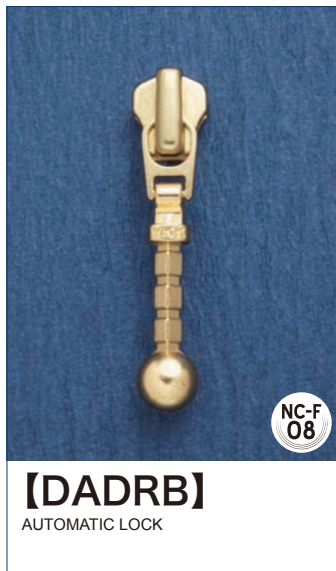
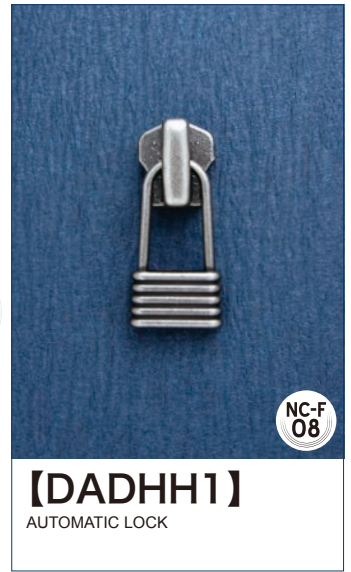

# YKK original sliders for METAL ZIPPERS

## 4M (Y)

for METAL ZIPPERS

4M (Y)



**[DUA]**

REVERSIBLE WITH AUTOMATIC LOCK  
FLIP-OVER / PRESS



**[CA]**

AUTOMATIC LOCK  
CLIP ON CRAMPER FOR ACCESSORY TAB

# 4Y

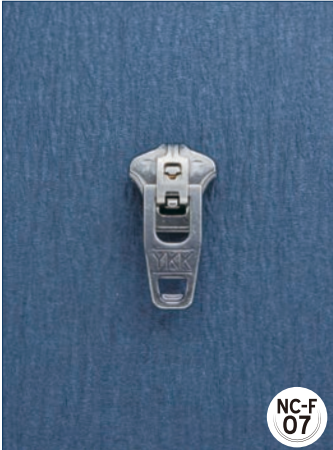

NC-F  
07

## **【GSBN8】**

SEMI-AUTOMATIC LOCK / DUAL POSITION  
PRESS

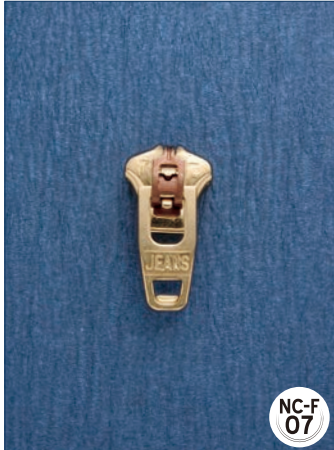

NC-F  
07

## **【GSBN8JNS】**

SEMI-AUTOMATIC LOCK / DUAL POSITION  
PRESS / JEANS MARK

YKK original sliders for METAL ZIPPERS

5M (Y)

for METAL ZIPPERS

5M (Y)



NC-F 08

**[DA8]**  
AUTOMATIC LOCK



NC-F 08

**[DA8BL9]**  
AUTOMATIC LOCK



NC-F 08

**[DA8BT3]**  
AUTOMATIC LOCK



NC-F 08

**[DA8CAB]**  
AUTOMATIC LOCK



**[DA8CRC23]**  
AUTOMATIC LOCK  
RING (23mm)





NC-F 08

**[DA8DC]**  
AUTOMATIC LOCK  
HOOK-CRAMPER



**[DA8DDH]**  
AUTOMATIC LOCK



**[DA8DHH]**  
AUTOMATIC LOCK



NC-F 08

**[DA8DHR9]**  
AUTOMATIC LOCK



NC-F 08

**[DA8DRB]**  
AUTOMATIC LOCK



NC-F 07

**[DA8DR4]**  
AUTOMATIC LOCK



NC-F 08

**[DA8DR7]**  
AUTOMATIC LOCK

# 5M (Y)

for METAL ZIPPERS

5M (Y)

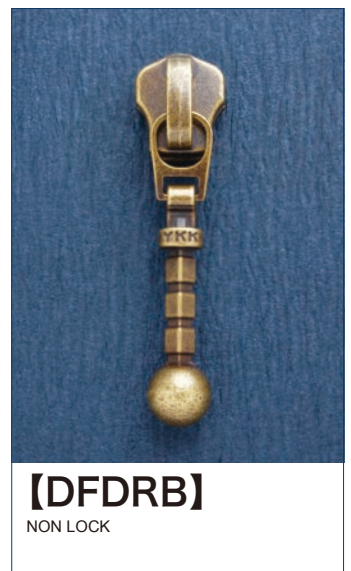
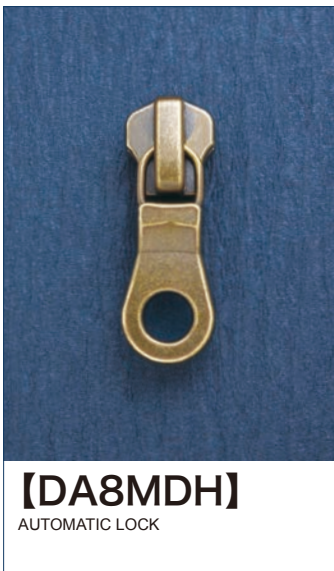
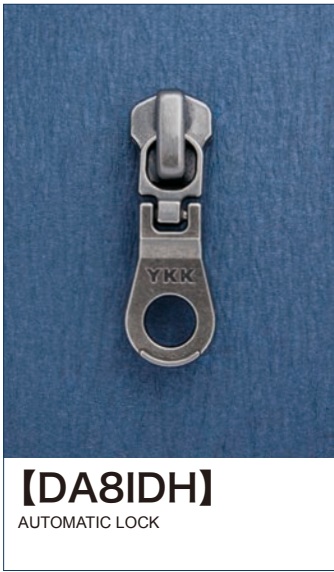

YKK original sliders for **METAL ZIPPERS**

**5M (Y)**

for METAL ZIPPERS

5M (Y)



**【DFDR4】**  
NON LOCK



**【DFDR7】**  
NON LOCK

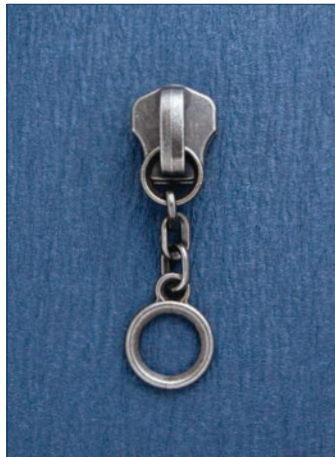

**【DFCA】**  
NON LOCK



**【DF CAB】**  
NON LOCK

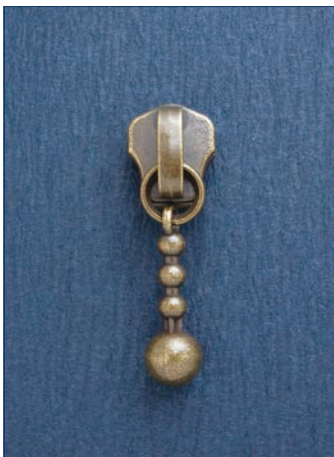

**【DFDBL】**  
NON LOCK



**【DFDC】**  
NON LOCK  
HOOK-CRAMPER



**【DF DHH1】**  
NON LOCK



**【DF DHR1】**  
NON LOCK



**【DFDOH】**  
NON LOCK



**【DF DRL】**  
NON LOCK



**【DF IDH】**  
NON LOCK

# 5M (Y)

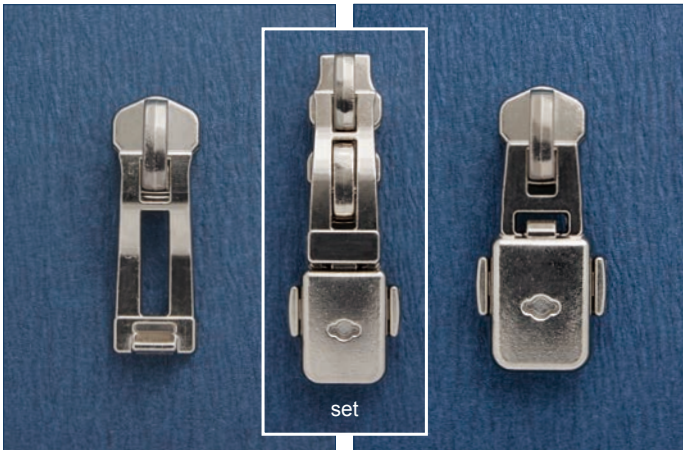

**set**

**【DFK-A1】**  
INTERCOUPLING LOCK  
KEY LOCK SLIDER WITH  
INTERCOUPLING TAB / CONVEX SIDE

**【DFK-B1】**  
INTERCOUPLING LOCK  
KEY LOCK SLIDER WITH  
INTERCOUPLING TAB / CONCAVE SIDE



**【DFL】**  
NON LOCK



**【DFOR】**  
NON LOCK  
RING (30mm)



**【DFSP】**  
NON LOCK



**【DFUR】**  
NON LOCK  
RING (25mm)



**【DFW】**  
NON LOCK

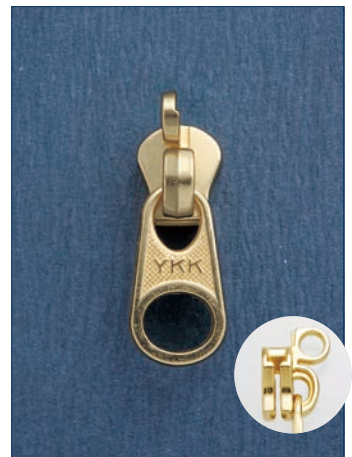

**【DFWK1】**  
NON LOCK  
TO LOCK SLIDER HEADS



**【DRL】**  
REVERSIBLE WITH NOTCH LOCK  
FLIP-OVER / PRESS



**【DU7】**  
REVERSIBLE WITH AUTOMATIC LOCK  
FLIP-OVER



**【GA1-25】**  
AUTOMATIC LOCK  
PRESS-25mm

NC-F 08



**【GSN8】**  
SEMI-AUTOMATIC LOCK / DUAL POSITION  
PRESS

NC-F 08

# YKK original sliders for METAL ZIPPERS

## 5M (Y)

for METAL ZIPPERS

5M (Y)



**NC-F 08**

**[GSN8JNS]**  
SEMI-AUTOMATIC LOCK / DUAL POSITION  
PRESS / JEANS MARK



**NC-F 07**

**[CA8]**  
AUTOMATIC LOCK  
CLIP ON CRAMPER FOR ACCESSORY TAB



**NC-F 07**

**[CF]**  
NON LOCK  
CLIP ON CRAMPER FOR ACCESSORY TAB



**NC-F 07**

**[ZA1]**  
AUTOMATIC LOCK  
SNAP-ON TYPE



**[ZF6]**  
NON LOCK  
SNAP-ON TYPE



# 7M



**[DA]**  
AUTOMATIC LOCK

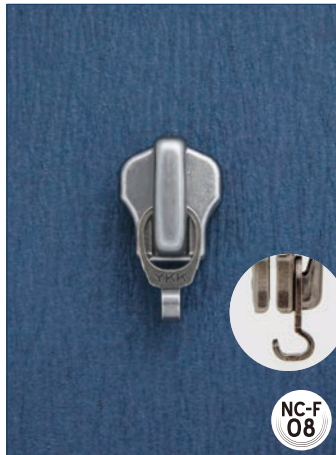

**[DADC]**  
AUTOMATIC LOCK  
HOOK-CRAMPER  
NC-F 08



**[DADHR1]**  
AUTOMATIC LOCK



**[DAL]**  
AUTOMATIC LOCK

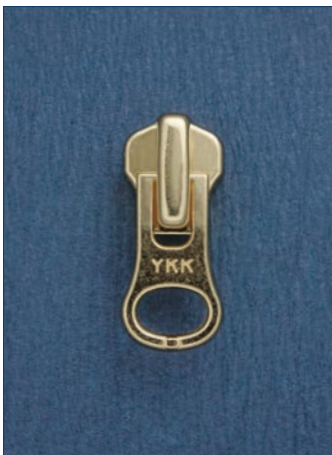

**[DALH]**  
AUTOMATIC LOCK

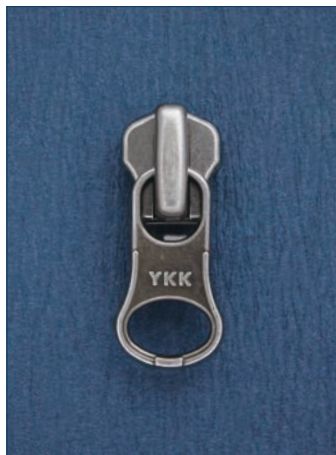

**[DALH3]**  
AUTOMATIC LOCK



**[DAP5]**  
AUTOMATIC LOCK



**[DAW10]**  
AUTOMATIC LOCK



**[DAMDH]**  
AUTOMATIC LOCK



**[DAMSL]**  
AUTOMATIC LOCK



**[DFL]**  
NON LOCK



**[DFOR]**  
NON LOCK  
RING (30mm)

# YKK original sliders for METAL ZIPPERS

## 7M

for METAL ZIPPERS

7M



**[DFW]**  
NON LOCK

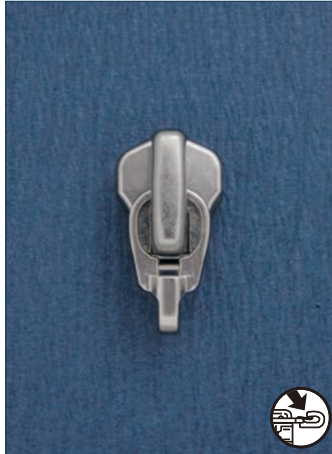

**[CA]**  
AUTOMATIC LOCK  
CLIP ON CRAMPER FOR ACCESSORY TAB

# 8M (Y)



**[DA]**  
AUTOMATIC LOCK



**[DADHR]**  
AUTOMATIC LOCK



**[DAL]**  
AUTOMATIC LOCK

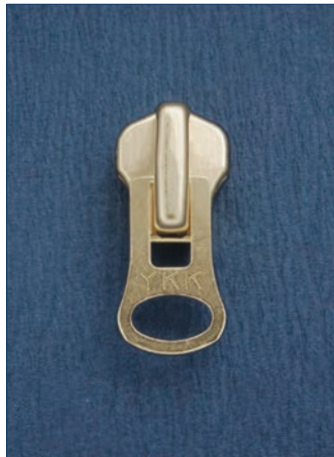

**[DALH]**  
AUTOMATIC LOCK  
PRESS



**[DALH7]**  
AUTOMATIC LOCK



**[DFL]**  
NON LOCK



**[DFOR]**  
NON LOCK  
RING (30mm)



**[DFW]**  
NON LOCK



**[ZA]**  
AUTOMATIC LOCK  
SNAP-ON TYPE

YKK original sliders for **METAL ZIPPERS**

**10M**

for METAL ZIPPERS

10M



**[DA]**  
AUTOMATIC LOCK



**[DADHR]**  
AUTOMATIC LOCK



**[DAL]**  
AUTOMATIC LOCK



**[DALH]**  
AUTOMATIC LOCK  
PRESS



**[DALH7]**  
AUTOMATIC LOCK



**[DDL]**  
NOTCH LOCK  
DOUBLE PULLS



**[DDW]**  
NOTCH LOCK  
DOUBLE PULLS



**[DFL]**  
NON LOCK



**[DFR20]**  
NON LOCK  
RING (20mm)



**[DFW]**  
NON LOCK



**[DNW]**  
NOTCH LOCK

## 2SG

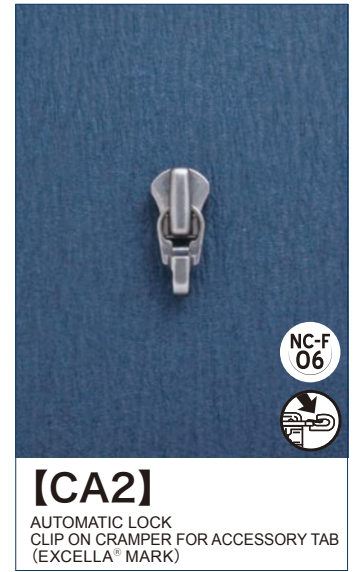
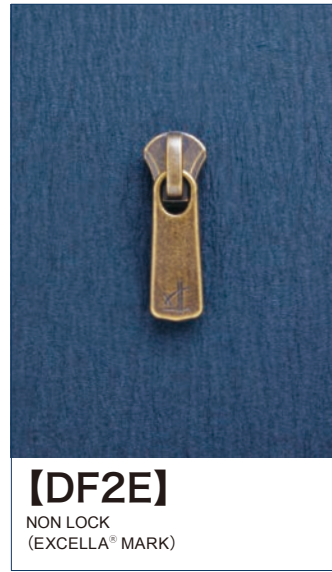

# 3SG

for METAL ZIPPERS

3SG

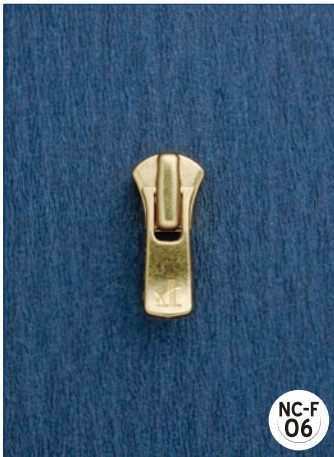

## **[DA2E]**

AUTOMATIC LOCK  
(EXCELLA® MARK)

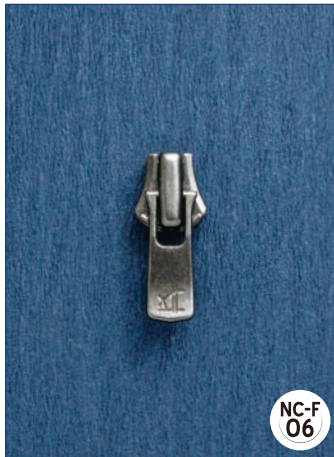

## **[DAG2E]**

AUTOMATIC LOCK  
FOR TWO-WAY SEPARATOR  
(EXCELLA® MARK)



## **[CA2]**

AUTOMATIC LOCK  
CLIP ON CRAMPER FOR ACCESSORY TAB  
(EXCELLA® MARK)

# 5SG



**【DA2E】**  
AUTOMATIC LOCK  
(EXCELLA® MARK)

NC-F  
08



**【DAG2E】**  
AUTOMATIC LOCK  
FOR TWO-WAY SEPARATOR  
(EXCELLA® MARK)

NC-F  
08



**【DF2E】**  
NON LOCK  
(EXCELLA® MARK)



**【CA2】**  
AUTOMATIC LOCK  
CLIP ON CRAMPER FOR ACCESSORY TAB  
(EXCELLA® MARK)

NC-F  
07

## 8SG



**[DA1]**  
AUTOMATIC LOCK



**[DA1DHR]**  
AUTOMATIC LOCK



**[DF2E]**  
NON LOCK  
(EXCELLA® MARK)



## 2SL



**【NFC】**

NON LOCK  
ALL PLASTIC

YKK original sliders for **COIL ZIPPERS**

## 2C (CF)

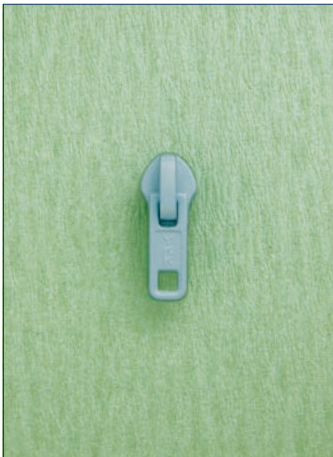

**[DF]**  
NON LOCK



**[DFCA]**  
NON LOCK



**[DFDRB]**  
NON LOCK



**[DFDR3]**  
NON LOCK



**[DFL]**  
NON LOCK



**[DFP1]**  
NON LOCK

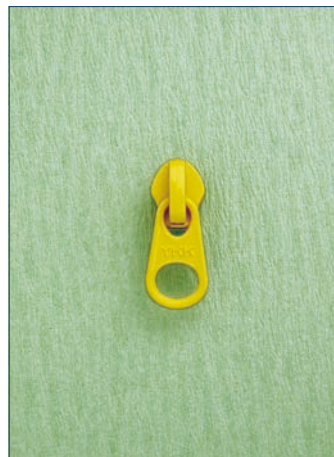

**[DFW]**  
NON LOCK

for COIL ZIPPERS

2C (CF)

# 3C (CF)



**【DA】**  
AUTOMATIC LOCK

NC-F 06  
CLOSED ONLY



**【DABL】**  
AUTOMATIC LOCK

NC-F 06  
CLOSED ONLY



**【DADHR7】**  
AUTOMATIC LOCK

NC-F 06  
CLOSED ONLY



**【DADR】**  
AUTOMATIC LOCK

NC-F 06  
CLOSED ONLY



**【DADRB】**  
AUTOMATIC LOCK

NC-F 06  
CLOSED ONLY



**【DADR4】**  
AUTOMATIC LOCK

NC-F 06  
CLOSED ONLY



**【DADR11】**  
AUTOMATIC LOCK

NC-F 06  
CLOSED ONLY



**【DADR12】**  
AUTOMATIC LOCK

NC-F 06  
CLOSED ONLY



**【DADR13】**  
AUTOMATIC LOCK

NC-F 06  
CLOSED ONLY



**【DADR14】**  
AUTOMATIC LOCK

NC-F 06  
CLOSED ONLY



**【DADR15】**  
AUTOMATIC LOCK

NC-F 06  
CLOSED ONLY



**【DALH5】**  
AUTOMATIC LOCK

NC-F 06  
CLOSED ONLY

# 3C (CF)



**[DAP1]**  
AUTOMATIC LOCK

NC-F 07

CLOSED ONLY



**[DAP2]**  
AUTOMATIC LOCK

NC-F 06

CLOSED ONLY



**[DAR20]**  
AUTOMATIC LOCK  
RING (20mm)

CLOSED ONLY



**[DARUH]**  
AUTOMATIC LOCK

NC-F 08

CLOSED ONLY



**[DASP]**  
AUTOMATIC LOCK

NC-F 07

CLOSED ONLY



**[DATDR2]**  
AUTOMATIC LOCK

NC-F 06

CLOSED ONLY



**[DA9]**  
AUTOMATIC LOCK

NC-F 06

CLOSED ONLY



**[DA9DR4]**  
AUTOMATIC LOCK

NC-F 06

CLOSED ONLY



**[DA9LH]**  
AUTOMATIC LOCK

NC-F 06

CLOSED ONLY



**[DA9MSL1]**  
AUTOMATIC LOCK

NC-F 06

CLOSED ONLY



**[DSYG]**  
SEMI-AUTOMATIC LOCK  
RUBBER PULL

NC-F 06

CLOSED ONLY



**[DAO17]**  
AUTOMATIC LOCK  
FOR OPEN

NC-F 06

for COIL ZIPPERS

3C (CF)

# 3C (CF)



**NC-F 06**

**【DAO17DR4】**  
AUTOMATIC LOCK  
FOR OPEN



**NC-F 06**

**【DAO17DR】**  
AUTOMATIC LOCK  
FOR OPEN





**NC-F 06**

**【DUO】**  
REVERSIBLE WITH AUTOMATIC LOCK  
FLIP-OVER FOR OPEN



**【DF】**  
NON LOCK



**【DFBL】**  
NON LOCK



**【DFBS】**  
NON LOCK



**【DFCA】**  
NON LOCK



**【DF CAB】**  
NON LOCK



**【DF CRR20】**  
NON LOCK  
RING (20mm)



**【DF DC3】**  
NON LOCK  
HOOK-CRAMPER



**【DF DBL】**  
NON LOCK



**【DF DRB】**  
NON LOCK

# 3C (CF)



**【DFDR2】**  
NON LOCK

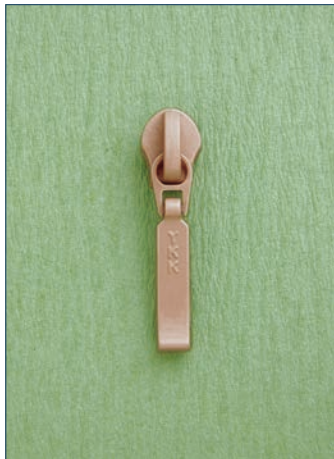

**【DFDR4】**  
NON LOCK



**【DFDR11】**  
NON LOCK

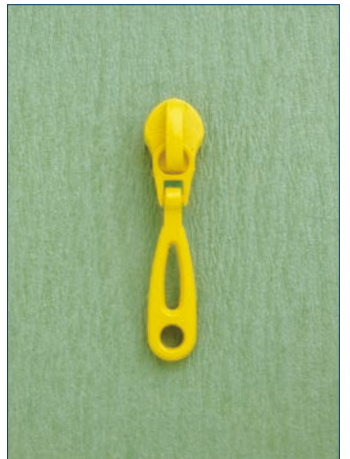

**【DFDR12】**  
NON LOCK



**【DFDR13】**  
NON LOCK

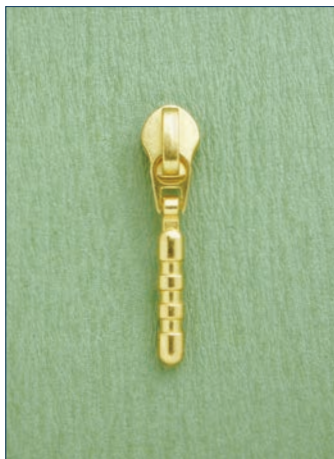

**【DFDR14】**  
NON LOCK



**【DFDR15】**  
NON LOCK



**【DFL】**  
NON LOCK



**【DFL1】**  
NON LOCK



**【DFP1】**  
NON LOCK



**【DFUR】**  
NON LOCK  
RING (20mm)

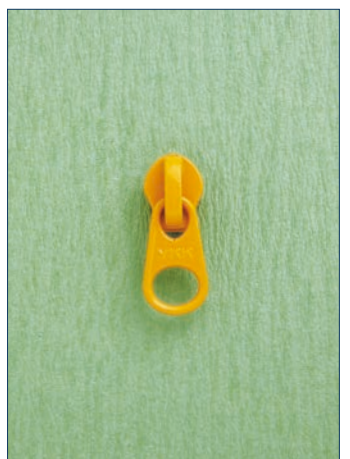

**【DFW】**  
NON LOCK

# 3C (CF)



**[DFW1]**  
NON LOCK



**[DF9L]**  
NON LOCK

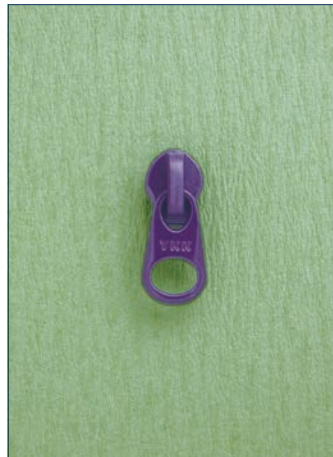

**[DF9W]**  
NON LOCK

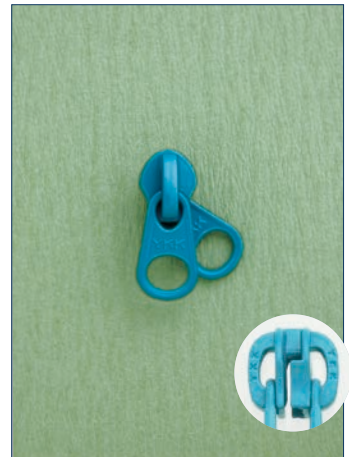

**[DWW]**  
NON LOCK  
DOUBLE PULLS

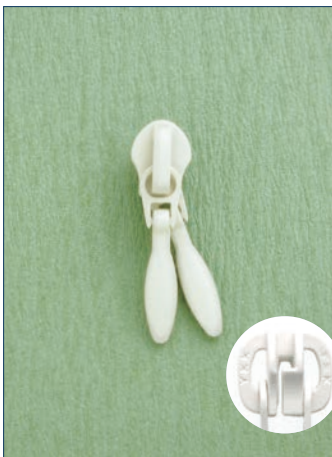

**[DWDR2]**  
NON LOCK  
DOUBLE PULLS



**[DWL]**  
NON LOCK  
DOUBLE PULLS

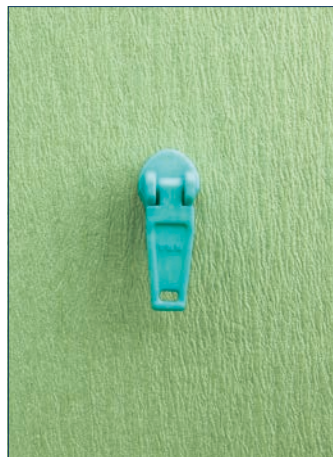

**[NFC]**  
NON LOCK  
ALL PLASTIC

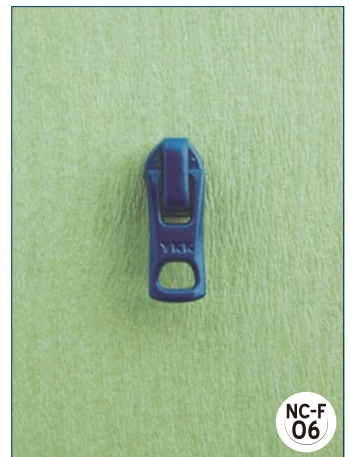

**[NA9]**  
AUTOMATIC LOCK  
PLASTIC EXCEPT LOCK PIN

NC-F  
06

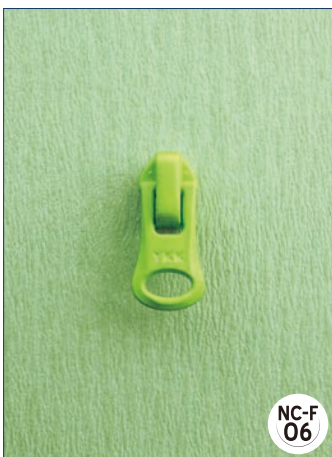

**[NA9LH2]**  
AUTOMATIC LOCK  
PLASTIC EXCEPT LOCK PIN

NC-F  
06

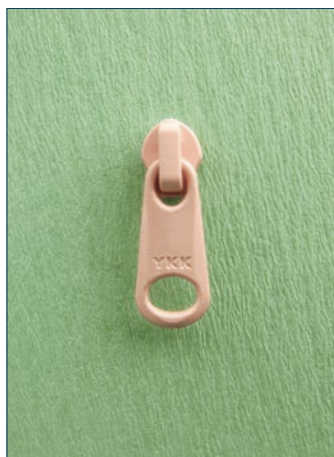

**[NF69L]**  
NON LOCK  
ALL PLASTIC

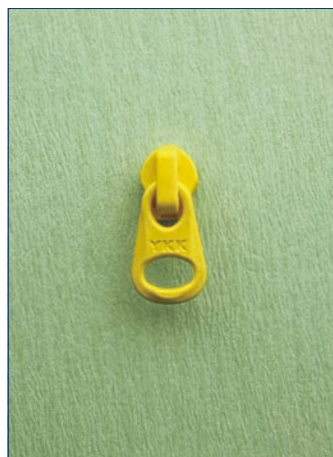

**[NF69W]**  
NON LOCK  
ALL PLASTIC

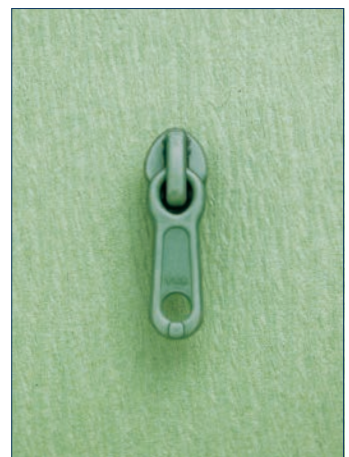

**[TFL1]**  
NON LOCK  
ALL PLASTIC

YKK original sliders for **COIL ZIPPERS**

**3C (CF)**

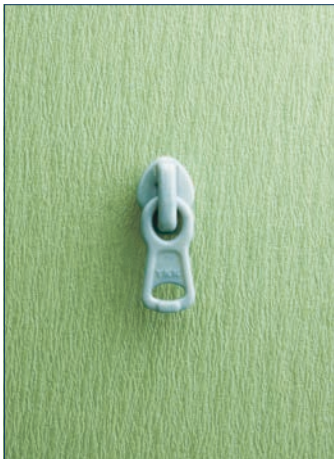

**[TFW]**

NON LOCK  
ALL PLASTIC



**[DAB]**

AUTOMATIC LOCK  
FOR REVERSED CHAIN ONLY



**[DABLH6]**

AUTOMATIC LOCK  
FOR REVERSED CHAIN ONLY



**[DAV17]**

AUTOMATIC LOCK  
FOR REVERSED CHAIN ONLY

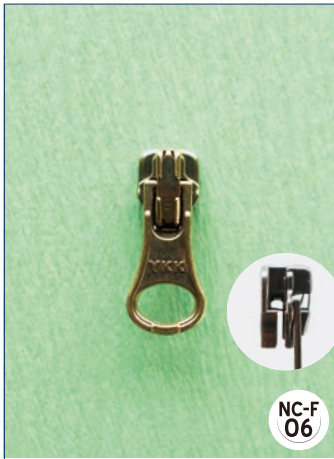

**[DAV17LH6]**

AUTOMATIC LOCK  
FOR REVERSED CHAIN ONLY



**[DFB-W]**

NON LOCK  
FOR REVERSED CHAIN ONLY



**[CA]**

AUTOMATIC LOCK  
CLIP ON CRAMPER FOR ACCESSORY TAB



**[CAO]**

AUTOMATIC LOCK  
CLIP ON CRAMPER FOR ACCESSORY TAB

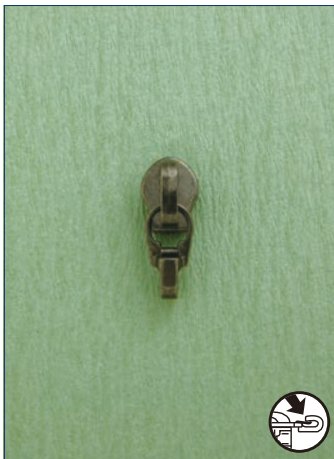

**[CF]**

NON LOCK  
CLIP ON CRAMPER FOR ACCESSORY TAB

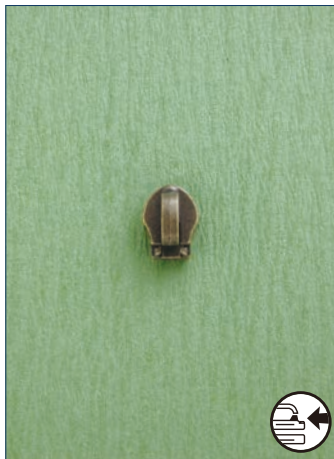

**[ZF]**

NON LOCK  
SNAP-ON TYPE



# 45C (CF)



# 45C (CF)

for COIL ZIPPERS

45C (CF)





**NC-F 07**

**[DS2YG]**  
SEMI-AUTOMATIC LOCK  
RUBBER PULL



**NC-F 07**

**[DS10]**  
SEMI-AUTOMATIC LOCK

**[DFDC]**  
NON LOCK  
HOOK-CRAMPER



**[DFDR4]**  
NON LOCK



**[DFL]**  
NON LOCK



**[DFUR]**  
NON LOCK  
RING (25mm)



**[DFW]**  
NON LOCK



**[TFL]**  
NON LOCK  
ALL PLASTIC



**NC-F 07**

**[CA4]**  
AUTOMATIC LOCK  
CLIP ON CRAMPER FOR ACCESSORY TAB



**[CF]**  
NON LOCK  
CLIP ON CRAMPER FOR ACCESSORY TAB

# 5CN (CI)

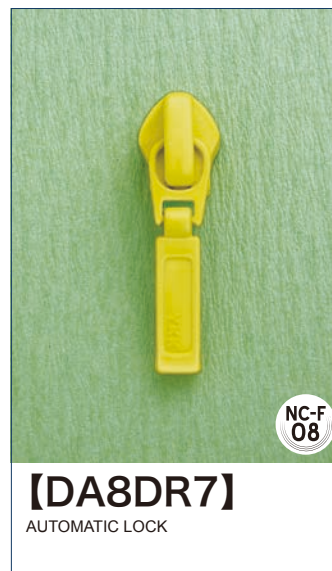
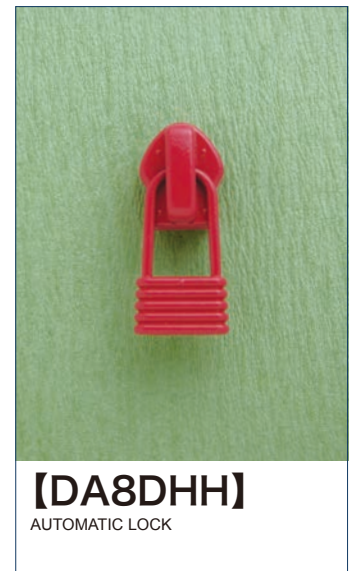
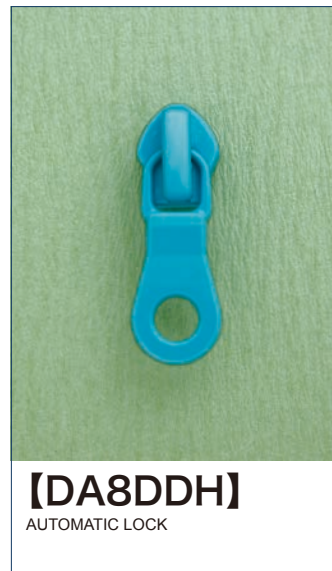
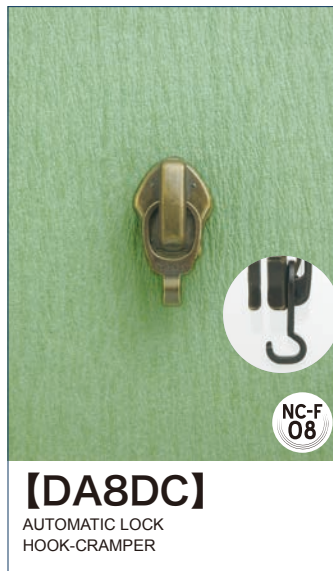
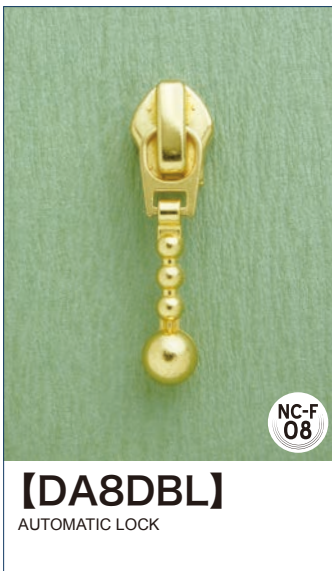

# 5CN (CI)

for COIL ZIPPERS

5CN (CI)



**【DA8LH】**  
AUTOMATIC LOCK



**【DA8LH1】**  
AUTOMATIC LOCK



**【DA8MDH】**  
AUTOMATIC LOCK



**【DA8MSL1】**  
AUTOMATIC LOCK



**【DA8P5】**  
AUTOMATIC LOCK

NC-F  
08



**【DA8R30】**  
AUTOMATIC LOCK  
RING (30mm)



**【DA8RL】**  
AUTOMATIC LOCK



**【DA8SP】**  
AUTOMATIC LOCK



**【DA8UR】**  
AUTOMATIC LOCK  
RING (30mm)



**【DA8UR2】**  
AUTOMATIC LOCK  
RING (25mm)

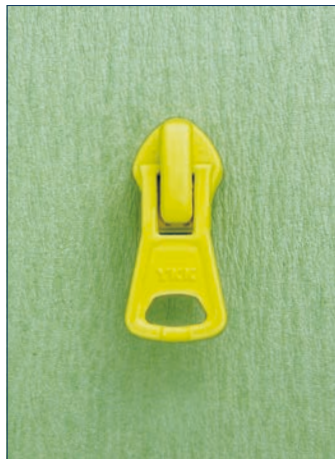

**【DA8W】**  
AUTOMATIC LOCK



**【DA9】**  
AUTOMATIC LOCK

NC-F  
08

# 5CN (CI)



**NC-F 08**

**【DA9DR7】**  
AUTOMATIC LOCK



**NC-F 08**

**【DA9DHR】**  
AUTOMATIC LOCK



**NC-F 08**

**【DA9LH】**  
AUTOMATIC LOCK



**NC-F 08**

**【DA9LH1】**  
AUTOMATIC LOCK



**NC-F 08**

**【DA9MSL】**  
AUTOMATIC LOCK



**NC-F 08**

**【DAG8】**  
AUTOMATIC LOCK  
FOR TWO-WAY SEPARATOR



**NC-F 08**

**【DS7YG】**  
SEMI-AUTOMATIC LOCK  
RUBBER PULL



**NC-F 08**

**【DS10】**  
SEMI-AUTOMATIC LOCK



**【DS13】**  
SEMI-AUTOMATIC LOCK



**【DFBS】**  
NON LOCK



**【DFCA】**  
NON LOCK



**【DFCAB】**  
NON LOCK

# 5CN (CI)



**【DFDBL】**  
NON LOCK



**【DFDC】**  
NON LOCK  
HOOK-CRAMPER

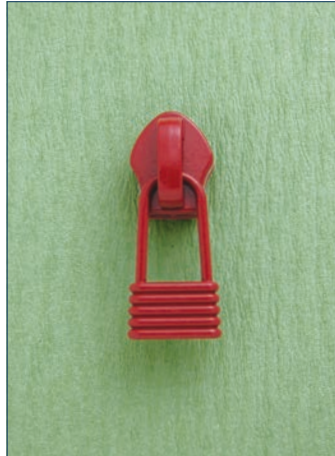

**【DFDHH1】**  
NON LOCK



**【DFDHR1】**  
NON LOCK

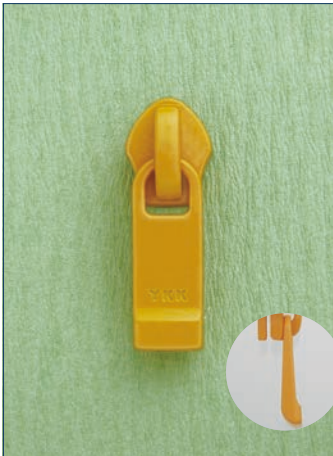

**【DFDOH】**  
NON LOCK



**【DFDRB7】**  
NON LOCK



**【DFDR7】**  
NON LOCK



**【DFL】**  
NON LOCK



**【DFL1】**  
NON LOCK



**【DFDR1】**  
NON LOCK



**【DFOR】**  
NON LOCK  
RING (30mm)

# 5CN (CI)



**[DFSP]**  
NON LOCK



**[DFUR]**  
NON LOCK  
RING (25mm)

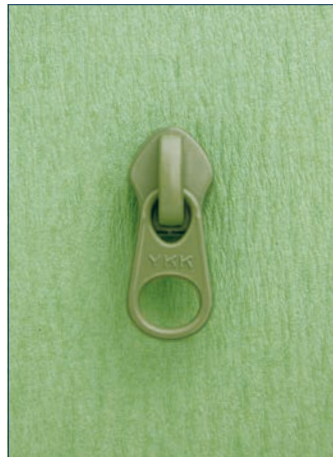

**[DFW]**  
NON LOCK



**[DFW1]**  
NON LOCK



**[DF9L]**  
NON LOCK

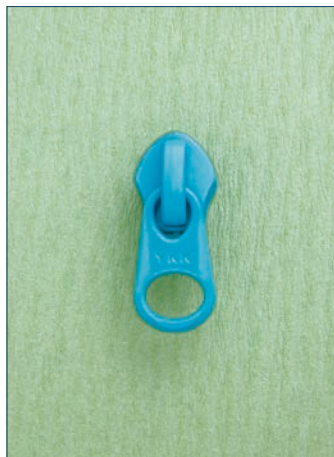

**[DF9W]**  
NON LOCK



**[DFK-A1]**  
INTERCOUPLING LOCK  
KEY LOCK SLIDER WITH  
INTERCOUPLING TAB / CONVEX SIDE

**[DFK-B1]**  
INTERCOUPLING LOCK  
KEY LOCK SLIDER WITH  
INTERCOUPLING TAB / CONCAVE SIDE



**[DK1B]**  
KEY LOCK SLIDER  
KEYS ON BALL CHAIN



**[DLW]**  
NON LOCK  
TO LOCK SLIDER HEADS



**[DU]**  
REVERSIBLE WITH AUTOMATIC LOCK  
FLIP-OVER



**[DWL]**  
NON LOCK  
DOUBLE PULLS

YKK original sliders for **COIL ZIPPERS**

**5CN (CI)**



**[DWW]**  
NON LOCK  
DOUBLE PULLS



**[DXDRL]**  
AUTOMATIC LOCK  
DOUBLE PULLS



**[DXL]**  
AUTOMATIC LOCK  
DOUBLE PULLS

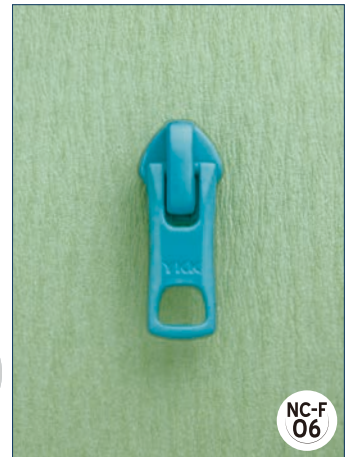

**[NA9]**  
AUTOMATIC LOCK  
PLASTIC EXCEPT LOCK PIN

NC-F  
06

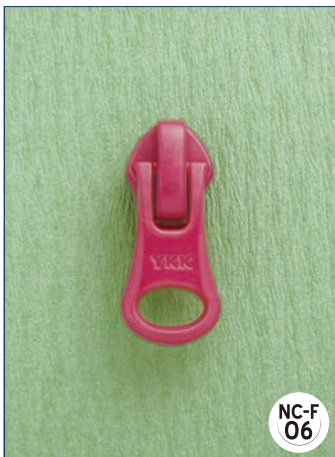

**[NA9LH2]**  
AUTOMATIC LOCK  
PLASTIC EXCEPT LOCK PIN

NC-F  
06

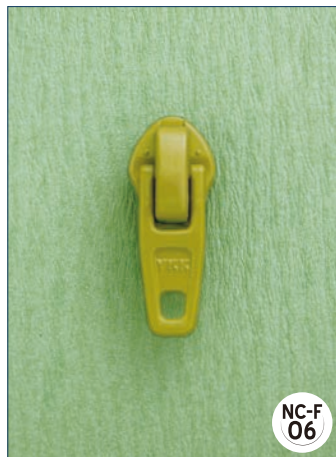

**[NC]**  
CAM LOCK  
ALL PLASTIC

NC-F  
06



**[NFL]**  
NON LOCK  
ALL PLASTIC



**[TFL]**  
NON LOCK  
ALL PLASTIC



**[TFW]**  
NON LOCK  
ALL PLASTIC



**[DA86B]**  
AUTOMATIC LOCK  
FOR REVERSED CHAIN ONLY

NC-F  
08

for COIL ZIPPERS

5CN (CI)



# 5CN (CI)

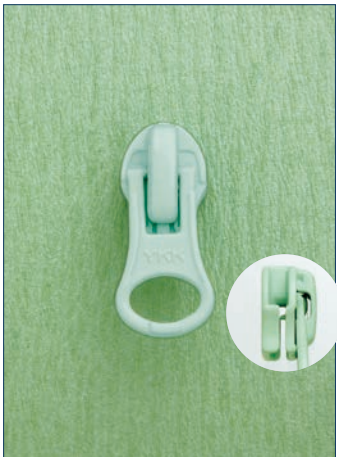

**【DA8BLH】**  
 AUTOMATIC LOCK  
 FOR REVERSED CHAIN ONLY

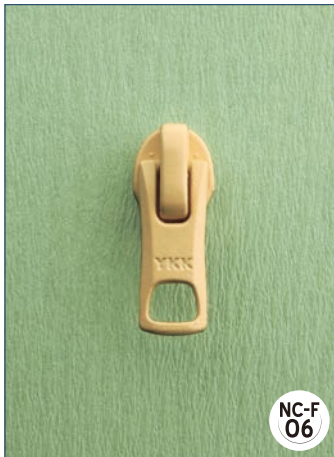

**【NAB9】**  
 AUTOMATIC LOCK  
 PLASTIC EXCEPT LOCK PIN  
 FOR REVERSED CHAIN ONLY

NC-F  
06

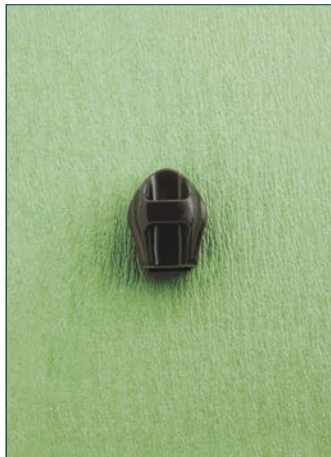

**【NF5B】**  
 NON LOCK  
 ALL PLASTIC  
 FOR REVERSED CHAIN ONLY



**【CA8】**  
 AUTOMATIC LOCK  
 CLIP ON CRAMPER FOR ACCESSORY TAB

NC-F  
08



**【CF】**  
 NON LOCK  
 CLIP ON CRAMPER FOR ACCESSORY TAB



**【ZA1】**  
 AUTOMATIC LOCK  
 SNAP-ON TYPE

NC-F  
08



**【ZF】**  
 NON LOCK  
 SNAP-ON TYPE



# 8C (CF)

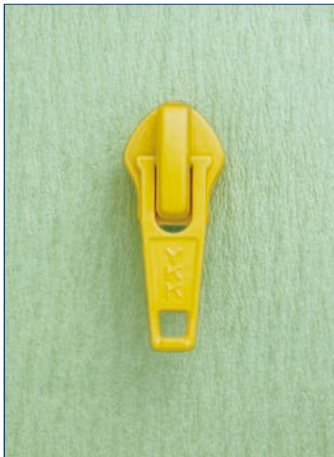

**[DA]**  
AUTOMATIC LOCK



**[DA3DC]**  
AUTOMATIC LOCK  
HOOK-CRAMPER



**[DADHR1]**  
AUTOMATIC LOCK



**[DADR7]**  
AUTOMATIC LOCK



**[DAL]**  
AUTOMATIC LOCK



**[DALH1]**  
AUTOMATIC LOCK



**[DASP]**  
AUTOMATIC LOCK



**[DAW]**  
AUTOMATIC LOCK



**[DAG]**  
AUTOMATIC LOCK  
FOR TWO-WAY SEPARATOR



**[DF3L]**  
NON LOCK



**[DF3OR]**  
NON LOCK  
RING (30mm)

## 8C (CF)



**【DF3W】**  
NON LOCK



**【DU3】**  
REVERSIBLE WITH AUTOMATIC LOCK  
FLIP-OVER



**【DW1L】**  
NON LOCK  
DOUBLE PULLS



**【DW1W】**  
NON LOCK  
DOUBLE PULLS

# 10C (CF)



**[DA8]**  
AUTOMATIC LOCK



**[DA8LH]**  
AUTOMATIC LOCK



**[DFL]**  
NON LOCK



**[DFUR]**  
NON LOCK  
RING (35mm)



**[DFW]**  
NON LOCK



**[DLW]**  
NON LOCK  
TO LOCK SLIDER HEADS



**[DW6L]**  
NON LOCK  
DOUBLE PULLS



**[DW6W]**  
NON LOCK  
DOUBLE PULLS

## 2CC (CH)



## 3CC (CH)



## 5CC (CH)

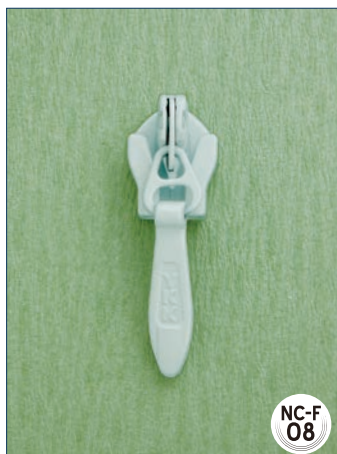

NC-F  
08

**[DA5]**

AUTOMATIC LOCK

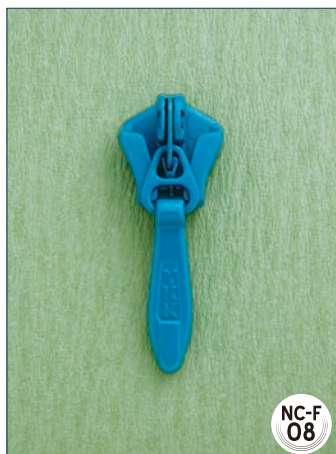

NC-F  
08

**[DA01]**

AUTOMATIC LOCK  
FOR OPEN

# OEF

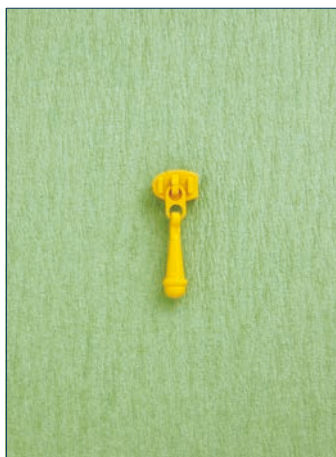

**【DF3DR】**

NON LOCK

for COIL ZIPPERS

OEF



# 4EF

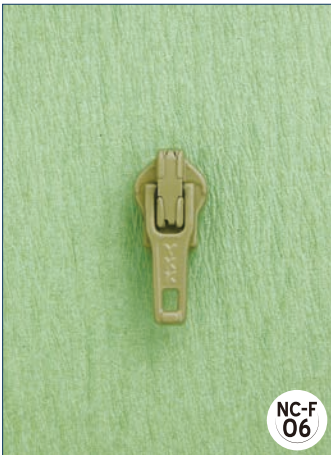

**【DA】**  
AUTOMATIC LOCK

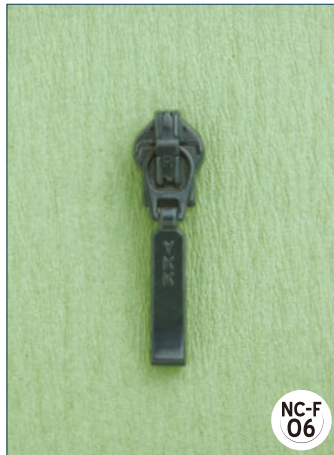

**【DADR4】**  
AUTOMATIC LOCK

# 5EF



for COIL ZIPPERS

5EF

# 65EY



**【DS1】**  
SEMI-AUTOMATIC LOCK

# 25FK

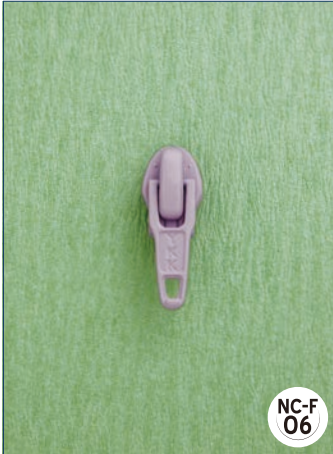

**[DA]**  
AUTOMATIC LOCK

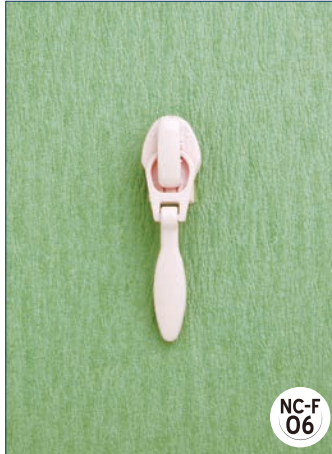

**[DADR2]**  
AUTOMATIC LOCK

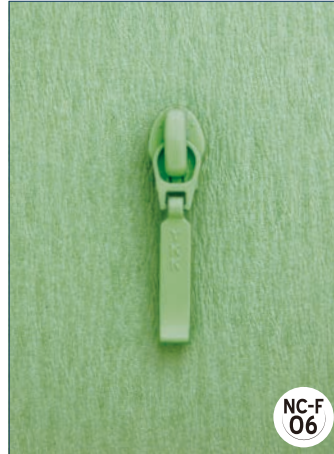

**[DADR4]**  
AUTOMATIC LOCK

# 3VS



# 3VS

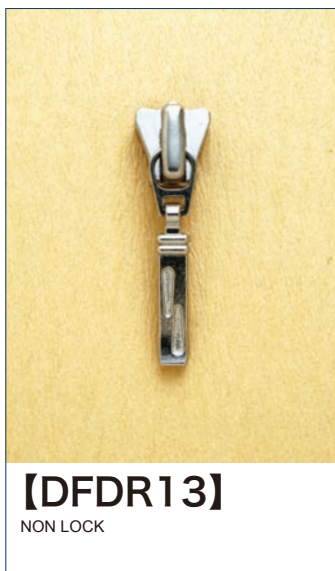
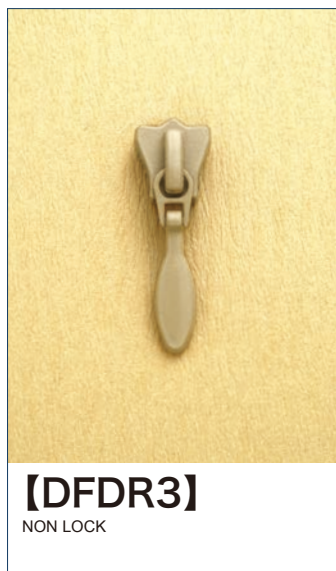

# 3VS



**[DFL]**  
NON LOCK



**[DFUR]**  
NON LOCK  
RING (25mm)



**[DF9L]**  
NON LOCK

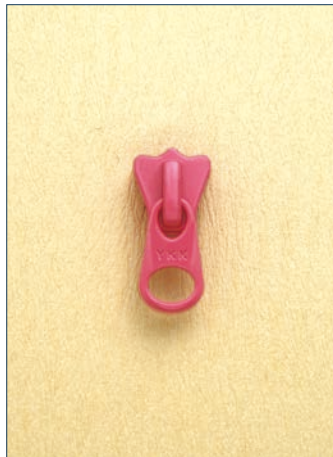

**[DF9W]**  
NON LOCK

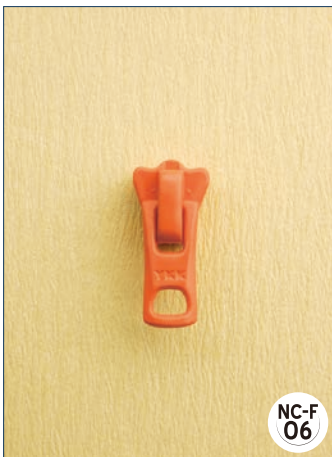

NC-F  
06

**[NA9]**  
AUTOMATIC LOCK  
PLASTIC EXCEPT LOCK PIN

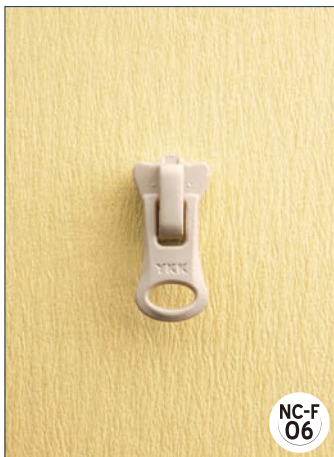

NC-F  
06

**[NA9LH2]**  
AUTOMATIC LOCK  
PLASTIC EXCEPT LOCK PIN



**[TFC1]**  
NON LOCK  
ALL PLASTIC

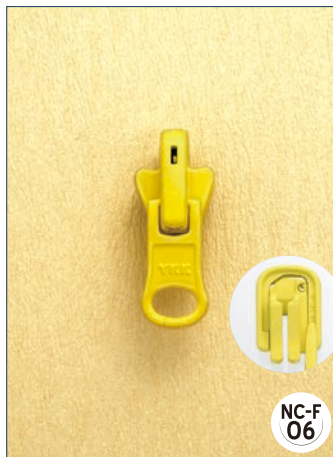

NC-F  
06

**[DU2]**  
REVERSIBLE WITH AUTOMATIC LOCK  
FLIP-OVER



NC-F  
06



**[CA]**  
AUTOMATIC LOCK  
CLIP ON CRAMPER FOR ACCESSORY TAB

# 4VS

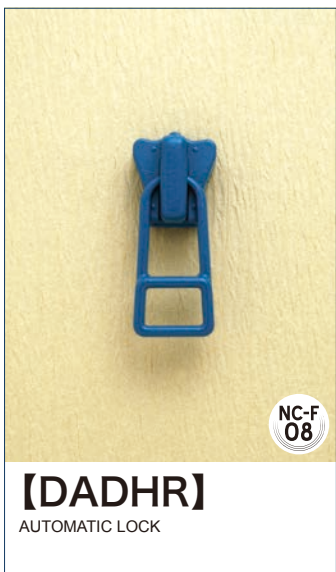



# 4VS



NC-F  
06

**[NA]**

AUTOMATIC LOCK  
PLASTIC EXCEPT LOCK PIN

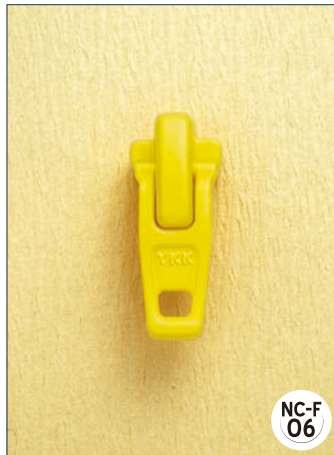

NC-F  
06

**[TA4]**

AUTOMATIC LOCK  
ALL PLASTIC



NC-F  
06



**[CA]**

AUTOMATIC LOCK  
CLIP ON CRAMPER FOR ACCESSORY TAB

# 5VS



**NC-F 08**

**【DA86】**  
AUTOMATIC LOCK



**NC-F 08**

**【DA8BT3】**  
AUTOMATIC LOCK



**NC-F 08**

**【DA8CRS】**  
AUTOMATIC LOCK



**NC-F 08**

**【DA8DBL】**  
AUTOMATIC LOCK



**NC-F 07**

**【DA8DC】**  
AUTOMATIC LOCK  
HOOK-CRAMPER



**NC-F 08**

**【DA8DHH】**  
AUTOMATIC LOCK



**NC-F 08**

**【DA8DHR9】**  
AUTOMATIC LOCK



**NC-F 08**

**【DA8LH】**  
AUTOMATIC LOCK



**NC-F 08**

**【DA8L】**  
AUTOMATIC LOCK



**NC-F 08**

**【DA8MDH】**  
AUTOMATIC LOCK



**NC-F 08**

**【DA8MSL1】**  
AUTOMATIC LOCK



**NC-F 08**

**【DA8P5】**  
AUTOMATIC LOCK

# 5VS



# 5VS

**[DA9LH1]**  
AUTOMATIC LOCK

NC-F 08

**[DA9MSL]**  
AUTOMATIC LOCK

NC-F 08

**[DS6YG]**  
SEMI-AUTOMATIC LOCK  
RUBBER PULL

NC-F 08

**[DF2DC]**  
NON LOCK  
HOOK-CRAMPER

NC-F 08

**[DF2L]**  
NON LOCK

NC-F 06

**[DF2UR]**  
NON LOCK  
RING (25mm)

NC-F 06

**[DF2W]**  
NON LOCK

NC-F 06

**[NA9]**  
AUTOMATIC LOCK  
PLASTIC EXCEPT LOCK PIN

NC-F 06

**[NA9LH2]**  
AUTOMATIC LOCK  
PLASTIC EXCEPT LOCK PIN

NC-F 06

**[TA]**  
AUTOMATIC LOCK  
PLASTIC EXCEPT LOCK PIN

NC-F 06

**[TA3]**  
AUTOMATIC LOCK  
ALL PLASTIC

NC-F 06

# 5VS



**【TF】**  
NON LOCK  
ALL PLASTIC

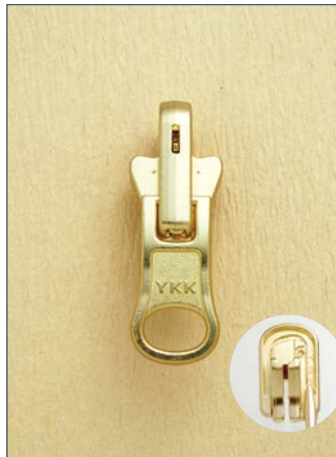

**【DU】**  
REVERSIBLE WITH AUTOMATIC LOCK  
FLIP-OVER

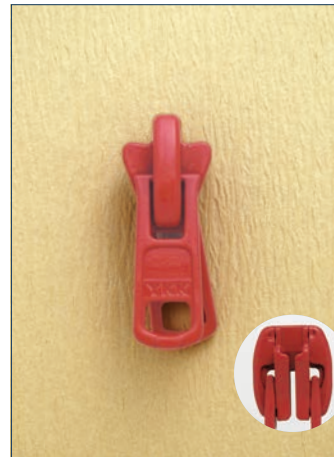

**【DX】**  
AUTOMATIC LOCK  
DOUBLE PULLS



**【DXL】**  
AUTOMATIC LOCK  
DOUBLE PULLS



**【DWL】**  
NON LOCK  
DOUBLE PULLS



**【DWW】**  
NON LOCK  
DOUBLE PULLS



**【TX2】**  
AUTOMATIC LOCK DOUBLE PULLS  
PLASTIC EXCEPT LOCK PIN  
NC-F 06

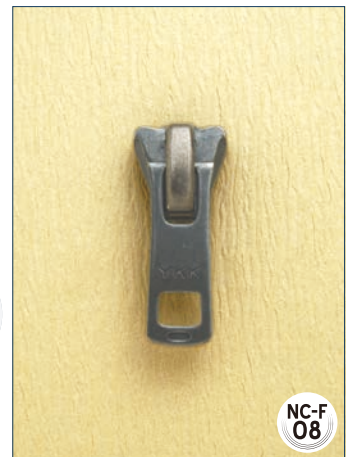

**【GA】**  
AUTOMATIC LOCK  
PRESS  
NC-F 08



**【GA20】**  
AUTOMATIC LOCK  
PRESS-20mm  
NC-F 08



**【ZA1】**  
AUTOMATIC LOCK  
SNAP-ON TYPE  
NC-F 07



**【CA8】**  
AUTOMATIC LOCK  
CLIP ON CRAMPER FOR ACCESSORY TAB  
NC-F 07

# 8VS



**[DA]**  
AUTOMATIC LOCK

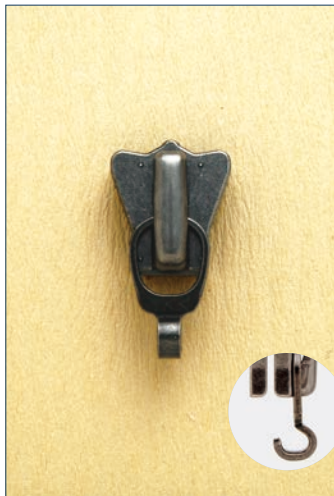

**[DADC]**  
AUTOMATIC LOCK  
HOOK-CRAMPER

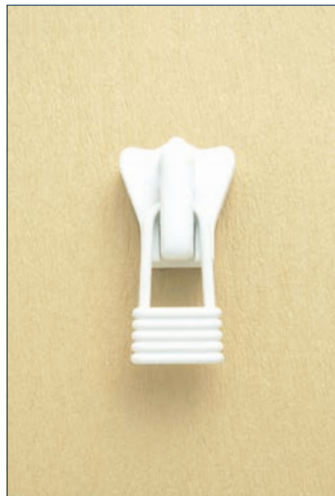

**[DADHH1]**  
AUTOMATIC LOCK



**[DADHR1]**  
AUTOMATIC LOCK



**[DADRL]**  
AUTOMATIC LOCK



**[DALH]**  
AUTOMATIC LOCK



**[DAMDH]**  
AUTOMATIC LOCK



**[DAMSL]**  
AUTOMATIC LOCK



**[DASP]**  
AUTOMATIC LOCK



**[DAUR]**  
AUTOMATIC LOCK  
RING (30mm)



**[DAG]**  
AUTOMATIC LOCK  
FOR TWO-WAY SEPARATOR



**[DFL]**  
NON LOCK

# 8VS



**【DFW】**  
NON LOCK



**【NA9】**  
AUTOMATIC LOCK  
PLASTIC EXCEPT LOCK PIN



**【NA9LH2】**  
AUTOMATIC LOCK  
PLASTIC EXCEPT LOCK PIN



**【DU】**  
REVERSIBLE WITH AUTOMATIC LOCK  
FLIP-OVER



**【DXL】**  
AUTOMATIC LOCK  
DOUBLE PULLS



**【DWL】**  
NON LOCK  
DOUBLE PULLS



**【DWW】**  
NON LOCK  
DOUBLE PULLS

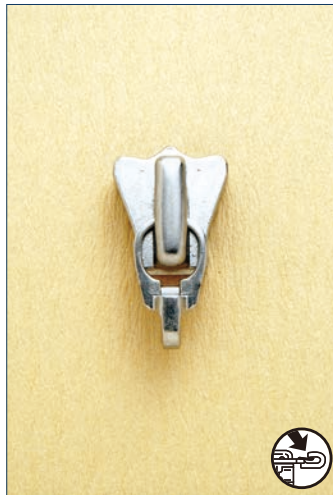

**【CA】**  
AUTOMATIC LOCK  
CLIP ON CRAMPER FOR ACCESSORY TAB

# 10V (VF)



**[DA]**  
AUTOMATIC LOCK



**[DADHR]**  
AUTOMATIC LOCK



**[DAUR35]**  
AUTOMATIC LOCK  
RING (35mm)



**[DAG]**  
AUTOMATIC LOCK  
FOR TWO-WAY SEPARATOR



**[DFL]**  
NON LOCK



**[DFW]**  
NON LOCK



**[TA6]**  
AUTOMATIC LOCK  
PLASTIC EXCEPT LOCK PIN



**[TAG]** ※※※  
AUTOMATIC LOCK  
PLASTIC EXCEPT LOCK PIN  
FOR TWO-WAY SEPARATOR



**[TF6]**  
NON LOCK  
ALL PLASTIC



**[DX]**  
AUTOMATIC LOCK  
DOUBLE PULLS



**[DWL]**  
NON LOCK  
DOUBLE PULLS



**[DWW]**  
NON LOCK  
DOUBLE PULLS



# 10V (VF)



**[DWG-L]**  
NON LOCK DOUBLE PULLS  
FOR TWO-WAY SEPARATOR



**[TX]** ※※※  
AUTOMATIC LOCK  
DOUBLE PULLS  
PLASTIC EXCEPT LOCK PIN

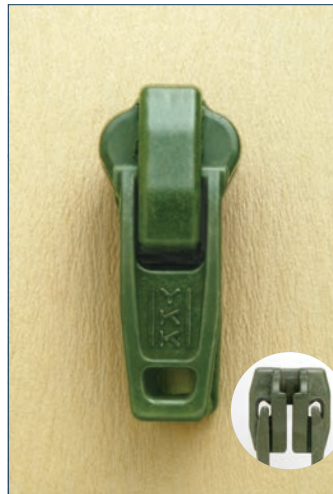

**[TW1]**  
NON LOCK  
DOUBLE PULLS  
ALL PLASTIC



**[KA]**  
AUTOMATIC LOCK  
STRONG TYPE / PRESS



**[SFNT]**  
NON LOCK  
STAINLESS / NON TAB



**[SWP]**  
SPECIAL PIN LOCK / SNAP  
DOUBLE PULLS  
STAINLESS

## 15V (VF)



**[NFN580]**

NON LOCK  
PLASTIC / NON TAB



**[SFNT]**

NON LOCK  
STAINLESS / NON TAB



**[SWNT]**

NON LOCK / STAINLESS  
NON TAB / DOUBLE TAB HOLDERS TYPE

# 4TZN



## 【BFSHR2】

NON LOCK / ALBC3  
WITH RUBBER PULL  
USE FOR CR TAPE

## 【BHSHP2】

NON LOCK / ALBC3  
WITH RUBBER PULL  
USE FOR PVC TAPE

# 8TZN



**【AFHR2】**

NON LOCK / ALBC3  
WITH RUBBER PULL

**【BFSHR2】**

NON LOCK / ALBC3  
WITH RUBBER PULL  
USE FOR CR TAPE

**【BFSHU2】**

NON LOCK / ALBC3  
WITH RUBBER PULL  
USE FOR PU TAPE

**【BFSHP2】**

NON LOCK / ALBC3  
WITH RUBBER PULL  
USE FOR PVC TAPE



 0120-13-4128

商品についてのご質問・ご不明な点は弊社営業担当者までお問い合わせください。または、弊社ホームページをご覧ください。  
[lyncs.ykkfastening.com](https://lyncs.ykkfastening.com)

- ・本紙に掲載されている内容を、弊社からの事前の承諾なく転載、複製、改変等することを禁止します。
- ・本紙に掲載されている商品の内容は、予告なく変更されることがあります。
- ・本紙に掲載されている個々の文章、写真、イラストその他一切の著作物の著作権並びに個々の商標、標章、商号に関する権利は、弊社または原著作者に帰属し、利用者にいかなる権利をも移転するものではありません。
- ・掲載されている商品写真は原寸大ではありません。また、写真の色味は、実際の商品色と異なる場合があります。
- ・本紙に掲載されている情報は、商品のすべての仕様、特性、注意事項を記載したものではありません。また、商品の最終製品への適合性を保証したものではありません。商品の採用及び使用におかれましては、必ずお客様ご自身で事前に使用用途、要求品質への適合性および安全性の検証をしたうえで、ご選択、ご使用ください。なお、使用に関する不具合や疑問点につきましては、弊社営業担当者までお問い合わせください。
- ・本紙に掲載されている情報は 2025 年 1 月時点のものです。

YKK、YKK Little Parts、Big Difference.、CONCEAL、EXCELLA、FLATKNIT、VISLON、PROSEAL、YZIP および EFLON は、日本およびその他の国/地域における YKK 株式会社の登録商標または商標です。



 **YKK CORPORATION**  
[lyncs.ykkfastening.com](http://lyncs.ykkfastening.com)